

# Converting Vehicles to Propane Autogas

## Part 4: Troubleshooting Four Current Autogas Fuel Systems

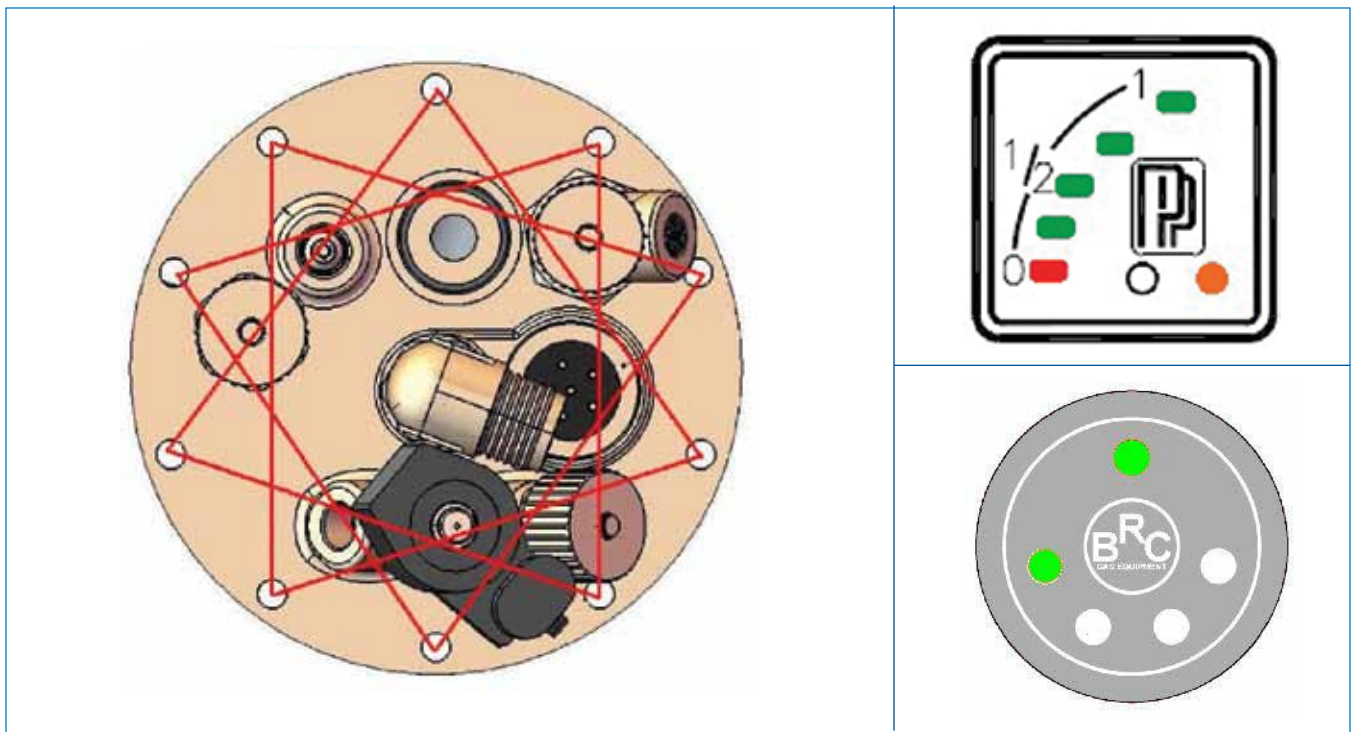



# Notice

---

*Users of this material should consult the law of their individual jurisdiction for the codes, standards and legal requirements applicable to them. This material merely identifies methods that the reader may find useful in implementing applicable codes, standards and legal requirements. This material is not intended nor should it be construed to:*

- (1) Set forth procedures which are the general custom or practice in the propane gas industry;*
- (2) Establish the legal standard of care owed by propane distributors to their customers;*
- (3) Prevent the reader from using different methods to implement applicable codes, standards or legal requirements.*

*This material was designed to be used as a resource only to assist expert and experienced supervisors and managers in training personnel in their organizations and does not replace federal, state, or company safety rules. The user of this material is solely responsible for the method of implementation. The Propane Education and Research Council and the Alternative Energy Division of the Railroad Commission of Texas assume no liability for reliance on the contents of this training material.*

*Issuance of this material is not intended to nor should it be construed as an undertaking to perform services on behalf of any party either for their protection or for the protection of third parties.*

*The use of specific products or manufacturers' trademarks, names or descriptions is for reference and not intended as an endorsement. The manufacturers' names, their products and component descriptive words and terminologies are trademarked and registered by their respective owners.*

*This manual is intended to help the technician diagnose certain commonly reported faults. The diagnostic procedures may not be fully endorsed by the fuel system manufacturer or the vehicle manufacturers, and OEM diagnostic procedures may not exist. The diagnostic procedures outlined in this manual reflect the recommendations of qualified alternative fuel diagnosticians including Railroad Commission staff members, manufacturers' representatives, and other qualified professional sources. A technical review committee has reviewed the diagnostic steps outlined in this manual.*

**Disclaimer:** *“This report was prepared as an account of work sponsored by an agency of the United States Government. Neither the United States Government nor any agency thereof, nor any of their employees, makes any warranty, express or implied, or assumes any legal liability or responsibility for the accuracy, completeness, or usefulness of any information, apparatus, product, or process disclosed, or represents that its use would not infringe privately owned rights. Reference herein to any specific commercial product, process, or service by trade name, trademark, manufacturer, or otherwise does not necessarily constitute or imply its endorsement, recommendation, or favoring by the United States Government or any agency thereof. The views and opinions of authors expressed herein do not necessarily state or reflect those of the United States Government or any agency thereof.”*

*All rights reserved. No part of this text may be reproduced, utilized, or transmitted in any form or by any means, electronic or mechanical, including photocopying, recording, or by any information storage and retrieval system, without permission in writing.*

© 2012 Propane Education & Research Council

## **Warning**



*Always consult recognized standards (NFPA 58 or equivalent) and Original Equipment Manufacturer (OEM) installation publications when working with propane autogas systems. Pressure in fuel tanks and other propane autogas system components may exceed 300 psig. Necessary safety precautions must be applied when installing, disconnecting or otherwise handling propane system components. Failure to apply adequate safety practices or failure to heed warnings while performing installation or repair procedures may result in serious personal injury or death to yourself or others.*

## Scope of This Course

This course covers diagnostics and troubleshooting of IMPCO/BRC Sequent, CleanFUEL USA LPI, Roush CleanTech LPI and Prins VSI autogas fuel systems.<sup>1</sup> It is Part 4 of a suite of courses on retrofitting, servicing and fueling vehicles that run on propane autogas. Part 1 covers the installation of fuel tanks, transfer lines and fittings. Part 2 covers the installation of underhood components, and Part 3 covers the installation and operation of propane autogas dispensers.

The purpose of this course is not to teach the user how to diagnose and repair every fault that may arise in each of the four fuel systems covered. The purpose is to provide information that will allow a skilled automotive technician who has limited experience with autogas and autogas fuel systems to address some commonly reported driver complaints safely and effectively.

At the time of this publication in the United States, the nationally recognized standards for autogas conversions are found in National Fire Protection Association manual 58, *Liquefied Petroleum Gas Code* (NFPA 58). Some states have adopted additional or different code requirements. Users should check with the authority having jurisdiction in their areas to determine which requirements apply.

### Additional references

CAN/CSA-B.149.5, *Canadian Installation Code for Propane Fuel Systems and Tanks on Highway Vehicles*; EN67, the European standard for vehicles converted to LP gas

NOTE: Canadian or European conversion standards are referenced to demonstrate that other options are available and practiced worldwide. It is the installer's responsibility to determine the appropriate practice to use for each individual installation.

In every aspect of a propane equipment installation, where explicit equipment manufacturers' installation instructions exist, those instructions must be followed.

---

<sup>1</sup> "Propane autogas" or "autogas" is the term used internationally to refer to propane used as an engine fuel to propel on-road vehicles.

## Acknowledgments

This material is based upon work supported by the Department of Energy, National Energy Technology Laboratory, under Award Number DE-EE0002564. The Railroad Commission of Texas gratefully acknowledges the assistance of CleanFUEL USA, IMPCO/BRC, Prins and Roush CleanTech in the preparation of these materials.

### **Franz Hofmann**

Railroad Commission of Texas, Alternative Energy Division, P.O. Box 12967, Austin, Texas 78711-2967, 512-463-8501, [franz.hofmann@rrc.state.tx.us](mailto:franz.hofmann@rrc.state.tx.us)

### **Dan Kelly**

Railroad Commission of Texas, P.O. Box 12967, Austin, Texas 78711-2967, 512-463-7291, [dan.kelly@rrc.state.tx.us](mailto:dan.kelly@rrc.state.tx.us)

### **Victor Fe**

MaxQuip, 9452 193A Street, Surrey, British Columbia V4N 4N4, 604-376-6494 [vfe@maxquip.ca](mailto:vfe@maxquip.ca)

### **Wayne Moore**

CleanFuel Technologies, 116 Halmar Cove, Georgetown, TX 78628, 512-864-0300, [wayne@cleanfuelusa.com](mailto:wayne@cleanfuelusa.com)

### **Robert Myers**

Boulder, Colorado, (303) 449-0764, [remyers38@aol.com](mailto:remyers38@aol.com)

### **Todd Mouw**

Roush CleanTech, 12068 Market St. Livonia, MI 48150, 800-597-6874, [todd.mouw@roush.com](mailto:todd.mouw@roush.com)

### **Gary Shepherd**

Stanford LP Gas, 3611 N. Eastman Road, Midland, MI 48642, 989-835-4754  
[gashepherd@slpg.net](mailto:gashepherd@slpg.net)

### **Rick Sweetzer**

IMPCO Technologies, 3030 South Susan Street, Santa Ana, California 92704, 714-656-1247, [rsweetser@IMPCOtechnologies.com](mailto:rsweetser@IMPCOtechnologies.com)

## Credits

CleanFUEL USA. Figs. 46, 47, 48, 51, 52, 53, 56, 57, 58, 68, 74, 80, 81, 82, 87, 89, 94, 97

ICOM North America. Fig. 45

IMPCO/BRC. Figs. 11, 16, 17, 18, 32, 33, 34, 39, 41, 43, 44

KD Tools. Fig. 102

National Propane Gas Association. Fig. 7; Table 1

Prins Maxquip. Figs. 116, 117

Unless otherwise noted, all other photos are by the author.

|  |            |
|--|------------|
| <b>Scope of This Course .....</b>  | <b>iii</b> |
| <b>Acknowledgments .....</b>   | <b>iv</b>  |
| <b>Credits .....</b>   | <b>v</b>   |
| Introduction.....  | ix         |
| <b>CHAPTER 1: Propane Fuel .....</b>   | <b>2</b>   |
| 1.1 History of LP-Gas as an Engine Fuel .....                                | 2          |
| 1.2 Changes in the Fuel Blend .....  | 2          |
| 1.3 Rapid Growth .....   | 3          |
| 1.4 Physical Characteristics and Properties .....                            | 3          |
| 1.5 Heat Content .....   | 3          |
| 1.6 Odorant .....  | 4          |
| 1.7 Specific Gravity.....  | 4          |
| 1.8 Boiling Point, Temperature, and Pressure .....                           | 5          |
| 1.9 Expansion Ratio .....  | 6          |
| 1.10 Flammability Limits .....   | 7          |
| 1.11 Combustion Air/Fuel Ratio .....   | 7          |
| 1.12 Octane Ratings.....   | 8          |
| 1.13 Combustion Characteristics .....  | 9          |
| 1.14 Emissions.....  | 10         |
| 1.15 Engine Performance .....  | 10         |
| 1.16 Engine Maintenance and Life .....                                       | 10         |
| 1.17 Propane Fuel Containers and Fuel Lines .....                            | 11         |
| Review of Chapter 1 - Propane Fuel .....                                     | 13         |
| <b>CHAPTER 2: Basic Safety Considerations .....</b>                          | <b>16</b>  |
| Review of Chapter 2 - Basic Safety Considerations .....                      | 18         |
| <b>CHAPTER 3: IMPCO/BRC Sequent Plug and Drive Vapor Fuel Injection.....</b> | <b>20</b>  |
| 3.1 System Overview .....  | 21         |
| 3.1.1 No operation on autogas .....  | 22         |
| 3.1.2 Fuel identification .....  | 23         |
| 3.1.3 Gasoline consumption .....   | 25         |
| 3.1.4 No automatic switch to autogas.....                                    | 26         |
| 3.1.5 No manual switch to gasoline .....                                     | 28         |
| 3.1.6 Automatic fuel switch during acceleration .....                        | 29         |
| 3.1.7 Gradual loss of power.....   | 30         |
| 3.1.8 Out of gasoline .....  | 32         |
| 3.1.9 No operation after refueling .....                                     | 33         |
| 3.1.10 Inaccurate fuel level gauge.....                                      | 35         |
| 3.1.11 Check engine light.....   | 36         |
| 3.1.12 Special spark plugs .....   | 38         |
| 3.2 Accessing the Sequent Diagnostic Program.....                            | 39         |
| 3.2.1 OBD-II parameter readouts.....   | 45         |



# Table of Contents

|  |            |
|--|------------|
| 3.2.2 Actuator testing .....   | 47         |
| 3.2.3 Injector sequencing .....  | 47         |
| 3.2.4 Replacing an injector .....  | 47         |
| 3.2.5 Maintenance .....  | 51         |
| 3.2.6 Setting the vaporizer outlet pressure .....                              | 52         |
| 3.2.7 Stored P1649 trouble code.....   | 54         |
| 3.2.8 Vapor purge or gas cap DTC.....  | 54         |
| Review of Chapter 3 - IMPCO/BRC Sequent Plug and Drive.....                    | 56         |
| <b>CHAPTER 4: CleanFUEL USA LPI Liquid Propane Injection Fuel System .....</b> | <b>58</b>  |
| 4.1 System Overview .....  | 58         |
| 4.1.1 Fuel lines.....  | 58         |
| 4.1.2 Electronic engine control.....   | 59         |
| 4.1.3 Diagnostic functions related to the PCM.....                             | 59         |
| 4.2 First Approach to Diagnosis .....  | 60         |
| 4.2.1 Hard starting .....  | 61         |
| 4.2.2 Slow refueling .....   | 62         |
| 4.2.3 Poor performance .....   | 64         |
| 4.2.4 Odor complaints .....  | 68         |
| 4.2.4.1 Identifying a leaky fuel injector .....                                | 69         |
| 4.2.4.2 Injector removal procedure.....  | 72         |
| 4.2.4.3 Fuel tank components .....   | 75         |
| 4.2.4.4 Tank evacuation .....  | 76         |
| 4.2.4.5 Fuel pump removal.....   | 77         |
| 4.3 Electrical System Interface.....   | 88         |
| Review of Chapter 4 - CleanFUEL USA Liquid Propane Injection .....             | 90         |
| <b>CHAPTER 5: Roush LPI Liquid Propane Fuel Injection .....</b>                | <b>94</b>  |
| 5.1 System Overview .....  | 94         |
| 5.1.1 Hard starting.....   | 95         |
| 5.1.2 Slow refueling.....  | 96         |
| 5.1.3 Poor performance.....  | 98         |
| 5.1.3.1 Isolating a defective fuel injector .....                              | 98         |
| 5.1.3.2 Replacing an injector .....  | 99         |
| 5.1.3.3 Testing tank and fuel delivery pressure.....                           | 102        |
| 5.1.3.4 Fuel tank evacuation .....   | 103        |
| 5.1.3.5 Fuel tank removal .....  | 104        |
| 5.1.3.6 Tank reassembly.....   | 108        |
| 5.1.4 Engine dies or runs rough.....   | 111        |
| <b>CHAPTER 6: Prins Vapor Sequential Injection System .....</b>                | <b>116</b> |
| 6.1 System Overview .....  | 116        |
| 6.1.1 Theory of operation .....  | 117        |
| 6.2 Basic System Operation.....  | 117        |
| 6.2.1 No operation on autogas.....   | 118        |

# Table of Contents

|  |            |
|--|------------|
| 6.3 Accessing the Prins Diagnostic Program .....                 | 121        |
| 6.3.1 Diagnostic procedures .....                                | 124        |
| 6.3.2 Prins trouble code chart .....                             | 125        |
| 6.3.3 Fuel identification.....                                   | 129        |
| 6.3.4 Gasoline consumption.....                                  | 131        |
| 6.3.5 No automatic switch to autogas .....                       | 132        |
| 6.3.6 No manual switch to gasoline.....                          | 133        |
| 6.3.7 Stall on switchover .....                                  | 134        |
| 6.3.8 Lean or rich DTC .....                                     | 135        |
| 6.3.9 Automatic fuel switch during acceleration .....            | 136        |
| 6.3.10 Gradual loss of power .....                               | 137        |
| 6.3.11 Engine misfires .....                                     | 140        |
| 6.3.12 Out of gasoline .....                                     | 141        |
| 6.3.13 No operation after refueling .....                        | 142        |
| 6.3.14 Inaccurate fuel-level gauge .....                         | 144        |
| 6.3.15 Check engine light.....                                   | 146        |
| 6.3.16 Special spark plugs.....                                  | 148        |
| 6.3.17 Erratic fuel switching .....                              | 149        |
| <b>CHAPTER 7: Malfunction Indicator Lights: OEM And LPG.....</b> | <b>154</b> |
| 7.1 MIL Illuminated .....  | 154        |
| 7.2 General Maintenance.....                                     | 156        |
| <b>Appendix A: Glossary .....</b>                                | <b>158</b> |
| <b>Appendix B: Material Safety Data Sheet.....</b>               | <b>163</b> |

## Introduction

This course is for technicians who are familiar with propane's physical properties, basic shop tool safety, electronic engine controls for spark-ignited engines, and OBD-II diagnostics.

Upon completion of the course, the technician should be able to:

- Identify four different current propane autogas fuel systems,
- Identify the most commonly reported operational faults,
- Identify and isolate possible failure areas, and
- Identify the most efficient means of repair.

The course covers four current autogas fuel systems: IMPCO/BRC Sequent, CleanFUEL USA LPI, Roush CleanTech LPI, and Prins Vapor Sequential Injection (VSI). The IMPCO/BRC Sequent and Prins VSI are bifuel systems that allow the vehicle to operate on either autogas or gasoline. These systems add components that replicate the original equipment manufacturer's fuel injectors, fuel tank and fuel lines, as well as components specific to autogas (fuel pressure vaporizing regulator and supplemental computer).

The CleanFUEL USA and Roush LPI systems are dedicated (autogas-only) systems. Gasoline and gasoline-related components are no longer present. The gasoline fuel tanks, fuel injectors, and all fuel-conveying plumbing are removed and replaced with autogas-specific components, and the original vehicle's computer is reflashed with a program optimized for propane.

Diagnostics differ for each of these systems, and virtually no components interchange. As the autogas fuel systems replicate the vehicle's gasoline fuel system, OEM-compatible electronic diagnostic tools are used to help determine specific vehicle repair needs. Supplemental diagnostic software running on a laptop computer is also required.

The course is not intended to be an exhaustive diagnostic and troubleshooting guide. It is intended to describe the most commonly reported performance issues and recommended diagnostic and repair procedures. These diagnostic steps lay the groundwork for more extensive repairs as outlined in the manufacturers' service manuals.

As a reminder, do not assume that because a vehicle has been converted to propane, any or all faults are propane-related. If a fault is found that may occur regardless of fuel (e.g., an electrical or charging system problem, emission warning light, no starter operation, misfire, slipping transmission, gear noise, or flat tires), verify the condition of the basic vehicle first.



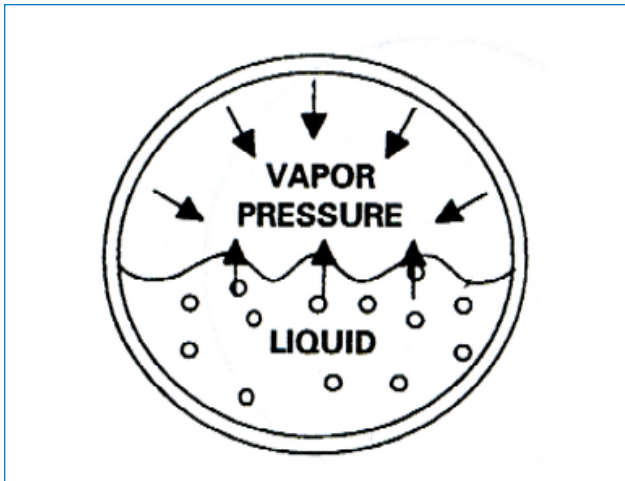
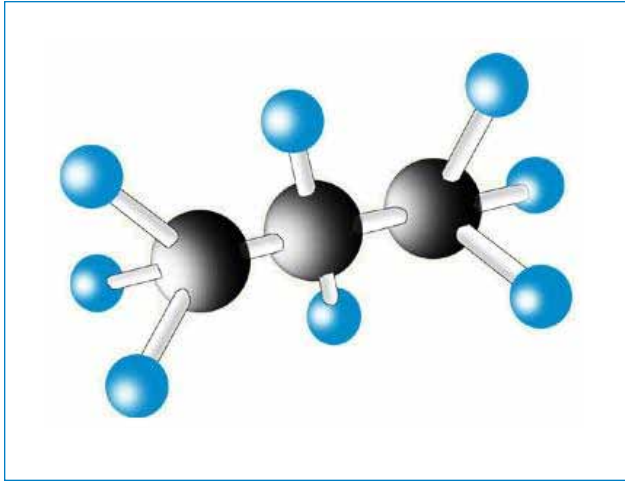

# **Chapter One**

## **Propane Fuel**

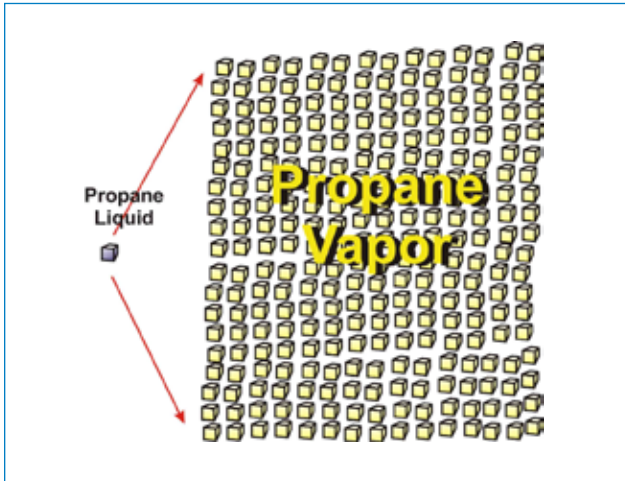

## CHAPTER 1: PROPANE FUEL

### 1.1 History of LP-Gas as an Engine Fuel

The use of LP-gas (liquefied petroleum gas) as an engine fuel is almost as old as the automobile itself. In the early 1900s, the main fuels available to power automobiles were gasoline and grain alcohol (ethanol). Gasoline rapidly became the overwhelming choice because of its price advantage and widespread availability, even though the refining practices of that time made it a highly volatile fuel that evaporated quickly.

Dr. Walter Snelling of the U. S. Bureau of Mines discovered a method of removing the lighter hydrocarbons from gasoline. He later identified these compounds as butane and propane, the primary constituents of LP-gas. The result improved motor gasoline and created a new LP-gas industry.

Dr. Snelling and his colleagues also devised methods for liquefying LP-gas. A practical means of separating butane and propane from crude oil and natural gas was developed, and the first automobiles powered by LP-gas appeared in the early 1900s.

### 1.2 Changes in the Fuel Blend

Until World War II, LP-gas engine fuel was mainly butane. The discovery of new uses for butane in gasoline blending and the petrochemical industry, however, shifted most of the available butane away from the engine fuel market. Propane became the primary component of LP-gas engine fuel.

In 1963 the Gas Processors Association (GPA) adopted specification HD-5 for propane engine fuel. The purpose was to provide a uniform quality propane, so engines could be designed and tuned to deliver the best performance and fuel economy. The specification is in GPA Standard 2140-97, *Liquefied Petroleum Gas Specifications and Test Methods*. It is incorporated as “special duty propane” in ASTM D-1835, *Standard Specification for Liquefied Petroleum (LP) Gases*.

The letters HD in HD-5 stand for “Heavy Duty,” and the number 5 represents the maximum percentage of propylene allowed in the fuel blend. HD-5 must be at least 90 percent propane and may contain up to 2.5 percent butane and heavier hydrocarbons by liquid volume. HD-5 must be essentially free from oily residues and other contaminants such as sulfur. A maximum vapor pressure of 208 psig at 100°F (Reid method) effectively limits ethane content.

HD-10 is the unofficial term for LPG with up to 10 percent propylene that meets the specifications set out in the California Code of Regulations, Title 13, Section 2292.6.

### 1.3 Rapid Growth

The 1973 Arab Oil Embargo increased public interest in propane engine fuel. Suddenly gasoline was in uncertain supply and expensive, resulting in rapid growth of propane fuel-system retrofits in the late 1970s and early 1980s. By 1978 about 35,000 vehicles a year were being converted to propane in the U.S. By 1981 that number was nearly 250,000. In 1989 almost 4 million vehicles worldwide were powered by propane autogas.

Regulatory actions increased demand for alternative-fueled vehicles in the 1990s. Some states, such as Texas, Florida, and California, required the use of these fuels as early as 1989. With the 1990 amendments to the Clean Air Act, the United States required the use of alternative fuels in certain fleets. Although the price gap between gasoline and propane has subsequently narrowed, environmental concerns and cost savings continue to motivate fleets to convert their vehicles.

### 1.4 Physical Characteristics and Properties

Like gasoline and diesel fuel, propane is a member of the hydrocarbon (HC) family. HC's are substances whose molecular structure is composed solely of hydrogen and carbon.

There are literally thousands of different HC's, ranging from those found in asphalts, heavy oils and waxes to gasoline, kerosene, naphtha and light gases such as methane, ethane, propane and butane. Gasoline is a mixture of 40 to 400 or more different HC's.

The number and arrangement of hydrogen and carbon atoms in a fuel's molecular structure is what gives each fuel its set of physical properties. At atmospheric pressure, propane ( $C_3H_8$ ), butane ( $C_4H_{10}$ ) and methane ( $CH_4$ ) are gases because of their relatively low molecular weight. At atmospheric pressure, gasoline, kerosene and diesel fuel are liquids because their molecules are much larger and heavier.

### 1.5 Heat Content

Heating values are measured in British thermal units (Btu's). One Btu is the amount of heat required to raise the temperature of one pound of water one degree Fahrenheit.

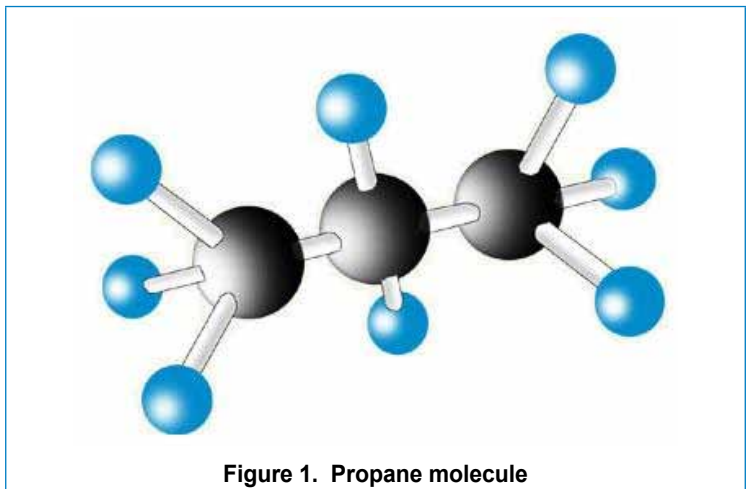

Figure 1. Propane molecule

Generally speaking, the more carbon atoms in a molecule of a given fuel, the greater its heat content or energy value. Table 1 on page 12 shows how much heat is produced when a given quantity of propane is burned. One gallon of propane will produce 91,502 Btu's of heat energy,

compared to 124,340 Btu's for one gallon of gasoline. By weight, one pound of propane produces 21,548 Btu's, which is almost the same as gasoline.

Although propane produces almost as much heat energy as gasoline on a per-pound basis, propane weighs about two pounds less per gallon than gasoline. An engine's horsepower output depends on the quantity (mass) of fuel burned, so even though propane requires a leaner air/fuel mixture than gasoline, the net result is that it takes more propane than gasoline by volume to achieve the same power output.

Gasoline engines converted to propane will generally consume 15-25 percent more fuel, in terms of miles per gallon.

## 1.6 Odorant

Propane is odorless by nature, like butane or methane. An odorant, usually ethyl mercaptan, is added to give propane its distinctive, pungent smell. The odorant acts as a warning agent so that leaks can be detected quickly. It is not harmful to breathe, nor does it affect the composition of the fuel in any way except to make its vapors noticeable. Once the fuel is burned, the odor disappears.

NFPA 58 states that odorization at the rate of one pound of ethyl mercaptan per 10,000 gallons of propane has been recognized as an effective odorant. This rate allows the average person to detect a combustible mixture of air and fuel at a level of not more than 1/5 the lower flammability limit (2.1 percent fuel to air).<sup>1</sup>

## 1.7 Specific Gravity

Propane liquid is lighter than water, and propane vapor is heavier than air. These physical characteristics are expressed as specific gravities.

The specific gravity of a liquid is defined as the weight of a given volume of the liquid compared to the weight of the same volume of water, measured at the same temperature and pressure.

The specific gravity of water is defined as 1.0. A liquid that is twice as heavy as water has a specific gravity of 2.0, and a liquid that is half as heavy as water has a specific gravity of 0.5. The specific gravity of propane liquid is 0.504, which means propane liquid weighs about half as much as water.

Similarly, the specific gravity of a gas (vapor) is defined as the weight of a given volume of the vapor compared to the weight of the same volume of air, measured at the same temperature and pressure.

<sup>1</sup> NFPA 58, 2008 and 2011 eds., §4.2.1



The specific gravity of air is defined as 1.0. A vapor that is twice as heavy as air has a specific gravity of 2.0, and a vapor that is half as heavy as air has a specific gravity of 0.5. The specific gravity of propane vapor is 1.50, which means propane vapor weighs half again as much as air.

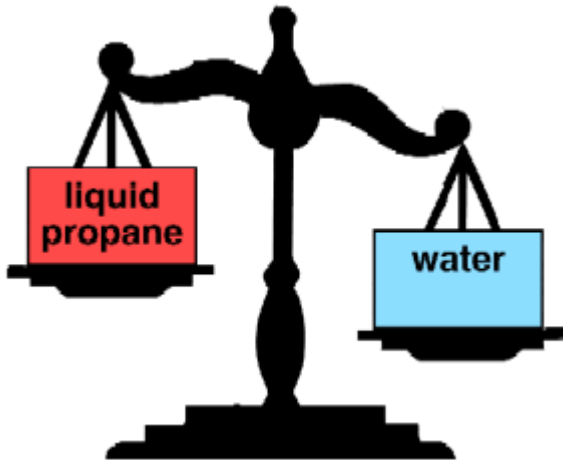

Figure 2. Propane liquid is lighter than water.

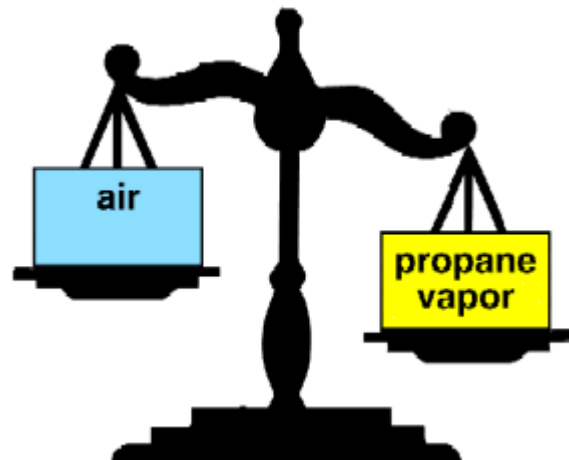

Figure 3. Propane vapor is heavier than air.

The specific gravity of propane vapor is an important physical property. Propane vapor is heavier than air. Therefore, it tends to initially accumulate at the lower level of spaces when it is released into a still environment. Sources of ignition, such as open flames, must be controlled in accordance with NFPA 58 wherever propane-fueled vehicles are parked or serviced indoors.

Repairs must be made either outdoors or in a well-ventilated area at least 25 feet away from any sources of ignition, such as smoking materials, open flames, electrical tools and lights, and at least 35 feet away from any metal grinding or oxy-welding operation. Fueling and venting operations must be performed only outdoors, and unauthorized personnel should be kept away from the repair area.

### 1.8 Boiling Point, Temperature, and Pressure

Another important physical property of propane is its low boiling point. At standard atmospheric pressure (sea level), pure propane liquid boils (vaporizes) at any temperature warmer than  $-44^{\circ}\text{F}$ . Below  $-44^{\circ}\text{F}$ , propane will remain liquid at standard atmospheric pressure.

At temperatures above  $-44^{\circ}\text{F}$ , propane will exist as a vapor unless it is kept under pressure, as in a container. Propane stored in a container exists as both a vapor and a liquid.

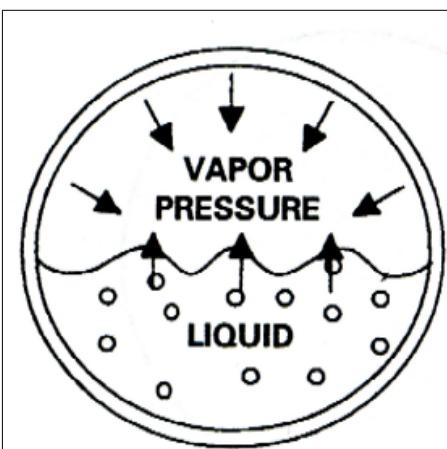

Figure 4. Propane liquid and vapor exist together in equilibrium inside a closed container.

The amount of pressure required to keep propane a liquid increases with temperature. At  $-20^{\circ}\text{F}$ , for example, very little pressure (only 10.7 psi) is required, because  $-20^{\circ}\text{F}$  is fairly close to propane's natural boiling point of  $-44^{\circ}\text{F}$ . At  $100^{\circ}\text{F}$ , however, 205 psi of pressure is required to keep propane a liquid, because the fuel is far above its boiling point. Figure 8 on page 11 shows the vapor pressure of propane at different temperatures.

If propane vapor or liquid is released from a container, the pressure in the container is reduced temporarily, causing the liquid propane to boil and generate vapor to fill the space above the liquid. Vaporization continues until a state of equilibrium is reached. When liquid is added to the container, the rising liquid compresses the gas in the vapor space, increasing the pressure inside the container. The propane vapor then starts condensing to liquid in order to restore equilibrium at that temperature. Propane inside a sealed tank will remain a liquid as long as the pressure is maintained.

Lowering the temperature lowers the vapor pressure inside a closed fuel tank, just as increasing the temperature raises the pressure. For this reason, hot days, cool nights, direct sunlight, rain and snow all affect the vapor pressure of the fuel inside a tank.

It is not unusual to see tank pressures change as much as 50 psi in the course of a day.

### 1.9 Expansion Ratio

The reason why propane is stored as a liquid under pressure is to save space. Liquid is denser than vapor, so much more fuel can be stored in a tank if the propane is in liquid form.

Like other liquids, propane expands when heated. But not all liquids expand at the same rate. Propane expands approximately one percent for each  $6^{\circ}\text{F}$  increase in its temperature.

To allow for expansion, propane fuel tanks are never completely filled with liquid. They are filled to approximately 80 percent of capacity to allow room for thermal expansion. Fuel tanks are also equipped with pressure relief valves that vent propane vapor if the internal tank pressure exceeds the preset rating of the valve. The valve closes automatically when internal pressure is reduced below this start-to-discharge pressure.

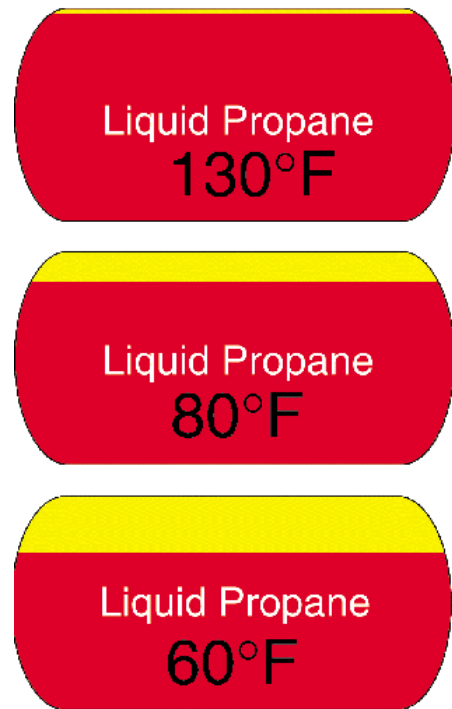

Figure 5. Propane liquid expands as temperature increases.

If propane liquid is released into the air, it quickly vaporizes and expands to 270 times its original volume. Therefore, a liquid propane leak can be more hazardous than a vapor leak due to the expanding vapor cloud.

Also, when liquid propane is released into the atmosphere, its rapid vaporization pulls heat from the surrounding air, causing a refrigerating effect that makes everything it touches extremely cold. If propane liquid contacts skin or other tissues, it can cause third-degree freeze burns.

### 1.10 Flammability Limits

A flammability limit is the lowest or highest percentage of fuel needed in an air/fuel mixture to support combustion. Combustion occurs when an air/fuel mixture that is within the flammability limits is ignited, e.g., by heat from a spark or compression.

Flammable air/fuel mixtures fall between the upper and lower flammability limits. The upper flammability limit is the greatest concentration of fuel—the richest air/fuel mixture—that will support combustion. Air/fuel mixtures above the upper limit will not burn because there is too much fuel and not enough air.

The lower flammability limit is the minimum concentration of fuel—the leanest air/fuel mixture—that will support combustion. Air/fuel mixtures below the lower limit will not burn because there is too much air and not enough fuel.

See Table 1 for the flammability limits of propane.

### 1.11 Combustion Air/Fuel Ratio

Although propane vapor will burn in any mixture within its limits of flammability, combustion is most efficient and complete when there is just the right amount of fuel for the available oxygen in the air. The ideal combustion ratio for propane, also referred to as the stoichiometric<sup>2</sup> air/fuel ratio, is 15.5:1 by weight, i.e., 15.5 pounds of air for every pound of propane vapor. The ratio is 24:1 by volume, i.e., 24 parts of air (96 percent) to every one part of propane vapor (4 percent). See Table 1.

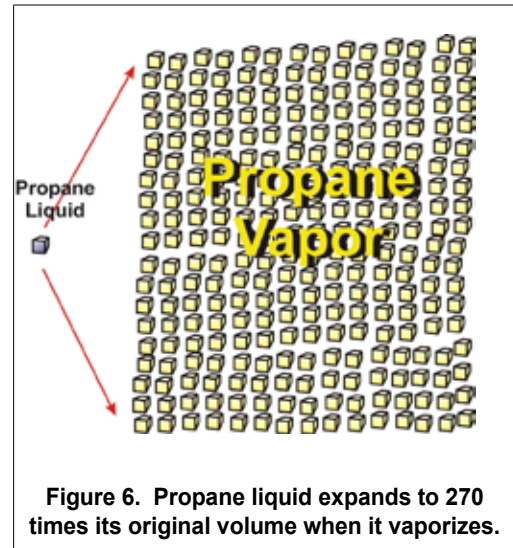

Figure 6. Propane liquid expands to 270 times its original volume when it vaporizes.

<sup>2</sup> The term “stoichiometry” is used to describe complete combustion. SAE standard J1829 defines “stoichiometric air-fuel ratio” as “the mass of air required to burn a unit mass of fuel with no excess of oxygen or fuel left over.” See [http://standards.sae.org/j1829\\_200210/](http://standards.sae.org/j1829_200210/).

An air/fuel mixture that is richer than the ideal ratio lacks enough oxygen to burn the fuel completely. The resulting partial combustion forms carbon monoxide (CO) and adds unburned hydrocarbons (HC's) to the exhaust emissions. Fuel economy suffers because excess fuel is being used. Richer mixtures tend to produce more power up to a certain point, but the trade-off is reduced performance and economy, increased exhaust emissions and higher exhaust temperatures.

If an air/fuel mixture is too lean, a condition known as lean misfire can occur inside the engine. Although the mixture may be above the lower flammability limit, it may be too lean for the spark to ignite. This allows unburned fuel vapors to pass through into the exhaust, increasing HC emissions. Performance is reduced because of the misfire, and economy suffers because of the wasted fuel.

### 1.12 Octane Ratings

Octane ratings measure a fuel's resistance to detonation. Propane's pump octane rating (100-105) is higher than that of any premium gasoline.

Detonation occurs when the pressures inside the combustion chamber become too great for the fuel to burn evenly. Instead of a smoothly expanding flame front inside the cylinder, multiple flame fronts are formed and collide with one another, producing a sharp pinging or spark knock that signals detonation. Vibration created by these colliding flame fronts can quickly damage an engine.

A fuel's resistance to detonation may be expressed in three different ways: research octane, motor octane, and pump octane. Research octane rating is determined in a laboratory by comparing the fuel's detonation resistance to that of two known test fuels: iso-octane (100 octane, the highest grade) and normal heptane (0 octane, the lowest grade). The fuel being tested is assigned a value relative to the ratio of a mixture of iso-octane to heptane that results in the equivalent knock resistance. The research method yields the highest octane rating of the three methods.

Motor octane ratings more accurately describe a fuel's resistance to detonation in actual service. In the motor octane test, the test fuel is evaluated in an engine that simulates actual driving conditions, resulting in lower octane numbers.

Pump octane is the rating posted on a fuel dispenser. It is calculated as  $R + M / 2 = P$ , or the sum of research octane and motor octane divided by 2 equals pump octane. The pump octane method yields average results of:

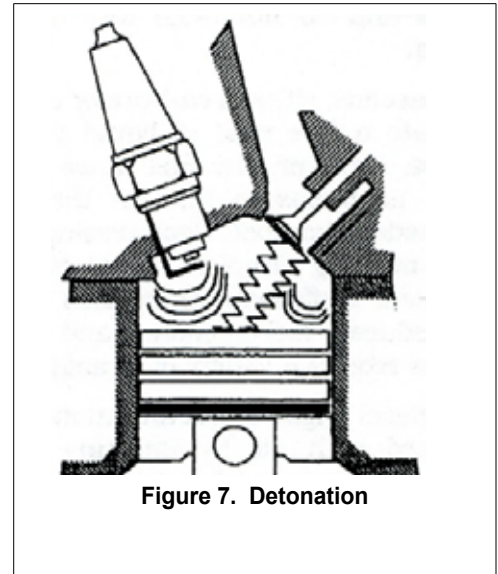

Figure 7. Detonation

- Regular unleaded gasoline = 87 octane
- Mid-grade unleaded gasoline = 89 octane
- Premium unleaded gasoline = 91-93 octane
- Propane (HD-5 / HD-10) = 100-105 octane (rating varies with the percentage of propane and other LP-gases)

### 1.13 Combustion Characteristics

Propane is a vapor at standard temperature (60°F) and standard atmospheric pressure (one atmosphere or 14.7 psi absolute). Gasoline and diesel fuel are liquids under these conditions. They must be vaporized to burn well.

In a gasoline fuel system, a carburetor or fuel injector creates a fine mist of liquid fuel. To vaporize completely, the fuel must pick up additional heat as it passes through the intake manifold and enters the combustion chamber. Compressing the fuel helps the droplets of gasoline mix and vaporize. If gasoline is not completely vaporized, inefficient combustion causes higher exhaust emissions and reduces fuel economy and performance. Therefore, gasoline engines require a variety of strategies to aid cold-starting.

With diesel engines, the situation is somewhat different. Diesel fuel is mixed with air by injecting it directly into the combustion chamber or pre-chamber as a highly pressurized mist. The fuel is not injected until the air inside the combustion chamber has been compressed and is extremely hot (around 1,000°F). Injection occurs a few degrees before the piston reaches top dead center on the compression stroke. The diesel fuel ignites the instant it hits the hot air. But because there is little time for the air and fuel to mix, diesel combustion is incomplete. As a result, diesels sometimes emit a lot of soot and other pollutants in their exhaust. For cold starting, a diesel engine must be cranked fast enough to heat the air inside the cylinders to the point where it will ignite the fuel. A glow plug system is required on many engines to provide the initial starting heat. Lighter grade diesel fuel must also be used during cold weather to prevent waxing and clogging of fuel lines and injectors.

Propane has excellent cold-start properties, because it enters the engine as a vapor at temperatures as cold as -40°F. This eliminates the need for cold-starting aids and allows the fuel to mix readily with air for efficient and clean combustion.

## 1.14 Emissions

All internal combustion engines produce emissions, but some fuels produce less than others. The main regulated compounds in engine exhaust are hydrocarbons, carbon monoxide, and various oxides of nitrogen (NO<sub>x</sub>). Some jurisdictions also regulate emissions of carbon dioxide (CO<sub>2</sub>).

In addition to catalytic converters that treat exhaust, late-model passenger cars and most light- and medium-duty trucks have charcoal canisters that trap evaporative emissions from the gasoline fuel tank. These vapors are drawn into the engine and burned when the engine is started. Although the canisters absorb much of the fuel vapor, a saturated canister can still release raw HC's into the atmosphere. Studies indicate that HC's may account for as much as 20 percent of total emissions from a vehicle.

Autogas fuel systems are sealed to maintain pressure and are therefore less likely to produce evaporative emissions.

## 1.15 Engine Performance

Many engines perform better on propane autogas than on gasoline. One reason is that propane mixes more readily with air. Propane's higher octane rating also allows the engine to use a more aggressive ignition timing curve at lower rpm and still resist detonation. On engines where timing is controlled by an on-board computer, some propane fuel systems use a modified OEM computer that has been reprogrammed with a new fuel and ignition timing map.

Another factor that contributes to increased performance is a denser air/fuel mixture entering the cylinders. Since propane is already vaporized when it enters the intake manifold, heating is not necessary or desirable. Lower intake temperatures promote a denser mixture for more power.

## 1.16 Engine Maintenance and Life

Clean combustion extends spark plug life, decreases valve train wear, and reduces wear on internal engine components, thus extending engine life and reducing maintenance costs.

When sludge and acid build up as a result of combustion blow-by, especially during engine warm-up, additives in the engine oil are rapidly used up. Bearings, rings, valve guides, cam lobes, and other friction surfaces wear more rapidly as the lubricant breaks down. Autogas virtually eliminates the buildup of carbon, varnish and sludge inside the engine. Fewer contaminants in the crankcase means that oil change intervals may be safely extended.

Specially formulated oils are available with additive packages designed for propane-powered engines. Additives that are used in regular motor oils to disperse acids and varnish are not

necessary in a propane-powered engine; in fact, they can form harmful deposits on the valves. Propane engine oils also contain additives that prevent the oil viscosity from changing or thickening when change intervals are extended.

Oils designed for propane service are not recommended for bifuel applications.

### 1.17 Propane Fuel Containers and Fuel Lines

Propane autogas containers are designed and built to American Society of Mechanical Engineers standards for pressure vessels. ASME tanks are significantly stronger and more resistant to damage or punctures than conventional gasoline fuel tanks.

Autogas tanks store fuel under pressures similar to those in conventional automotive air-conditioning systems, truck air-brake systems or large truck tires. The tanks are rated for more than 3½ times their maximum working pressure (960 psig burst pressure, or more).

Autogas moves from the tank to the engine through fuel lines that are rated for more than five times their maximum anticipated working pressure (350 psig working pressure, 1,750 psig burst pressure, or more).

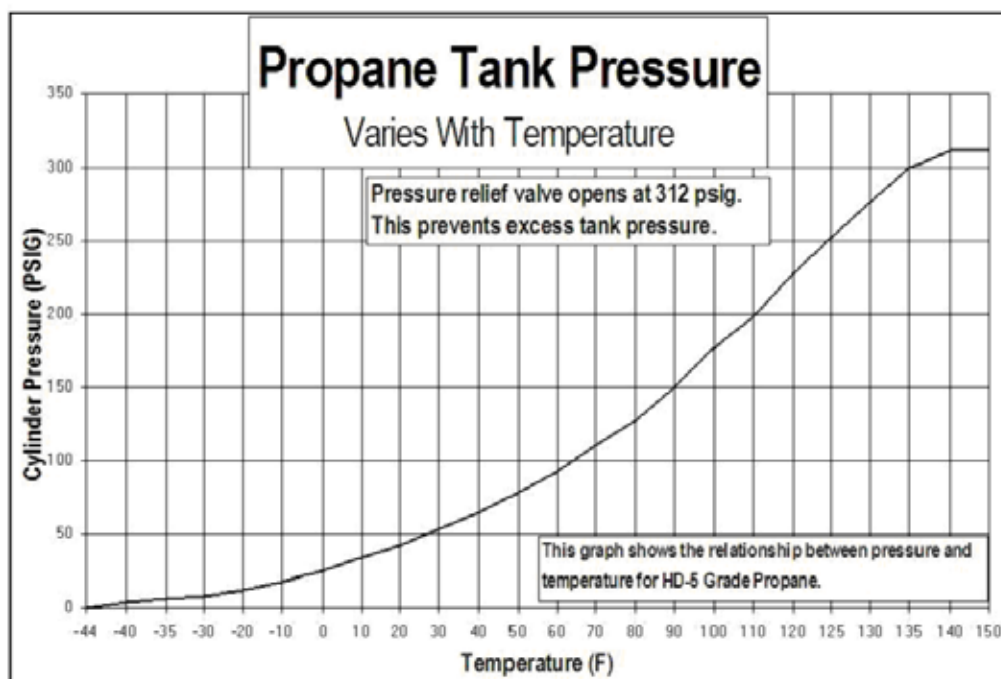

Figure 8. Vapor pressure of HD-5 propane

**Vapor Pressure.** The vapor pressure of propane in a container varies with temperature. Figure 8 shows propane’s vapor pressure index (VPI).

**Table 1. Physical Properties of Propane**

|   |                                     |
|---|-------------------------------------|
| Chemical Formula                                  | $C_3H_8$                            |
| Vapor Pressure at:                                | (in psig)                           |
| -44°F   | 0                                   |
| -20°F   | 10.7                                |
| 70°F  | 127                                 |
| 100°F   | 196                                 |
| 105°F   | 210                                 |
| 130°F   | 287                                 |
| Specific gravity of liquid at 60°F                | 0.504                               |
| Initial boiling point at 14.7 psig in °F          | -44°F                               |
| Weight per liquid gallon at 60°F                  | 4.20 lbs                            |
| Specific heat of liquid (BTU/lb at 60°F)          | 0.63                                |
| Cu. ft. of vapor per liquid gallon at 60°F        | 36.38                               |
| Cu. ft. of vapor per pound at 60°F                | 8.66                                |
| Specific gravity of vapor (air = 1) at 60°F       | 1.5                                 |
| Ignition temperature in air                       | 920-1120°F                          |
| Maximum flame temperature in air                  | 3,595°F                             |
| Limits of flammability in air, in % of gas to air | 2.1% to 9.6% (lean and rich limits) |
| Ideal air-to-fuel ratio by volume                 | 24:1                                |
| Ideal air-to-fuel ratio by weight                 | 15.5:1                              |
| Latent heat of vaporization at boiling point      |                                     |
| BTU per pound                                     | 184                                 |
| BTU per gallon                                    | 773                                 |
| Total heating value after vaporization            |                                     |
| BTU per cubic foot                                | 2,488                               |
| BTU per pound                                     | 21,548                              |
| BTU per gallon                                    | 91,502                              |
| Octane ratings                                    |                                     |
| Research  | 110                                 |
| Motor   | 95                                  |
| Pump  | 103                                 |



## Review of Chapter 1 - Propane Fuel

**Directions:** Select from the list below the response that most correctly completes each of the following statements. Write the letter of your choice in the space provided. Answers may be used more than once.

- |                |              |
|----------------|--------------|
| A. -44         | J. 10        |
| B. heavier     | K. frostbite |
| C. colorless   | L. 0.504     |
| D. 1           | M. 1.50      |
| E. 1 1/2%      | N. lighter   |
| F. 24          | O. 270       |
| G. 15.5        | P. 1/2       |
| H. natural gas | Q. 6         |
| I. NFPA 58     | R. 1.5       |

- \_\_\_ 1. Propane vapor is \_\_\_\_\_ than air.
- \_\_\_ 2. Propane liquid weighs \_\_\_\_\_ as much as water.
- \_\_\_ 3. Propane expands in volume \_\_\_\_\_ times when it boils and changes from liquid to vapor.
- \_\_\_ 4. The specific gravity of propane vapor is \_\_\_\_\_.
- \_\_\_ 5. The stoichiometry ratio for propane by weight is \_\_\_\_\_:1.
- \_\_\_ 6. Propane is produced by the processing of crude oil and/or \_\_\_\_\_.
- \_\_\_ 7. Propane liquid is \_\_\_\_\_ than water.
- \_\_\_ 8. The boiling point of propane liquid at normal atmospheric pressure is \_\_\_\_\_ degrees F.
- \_\_\_ 9. The ideal air-to-fuel ratio of propane by volume is \_\_\_\_\_:1.
- \_\_\_ 10. The specific gravity of propane liquid is \_\_\_\_\_.
- \_\_\_ 11. Liquid propane can cause \_\_\_\_\_ when it comes in contact with body tissue.
- \_\_\_ 12. Propane liquid expands approximately \_\_\_\_\_ percent for every \_\_\_\_\_ degrees F increase in temperature.
- \_\_\_ 13.



# ***Chapter Two***

## ***Basic Safety Considerations***

## CHAPTER 2: BASIC SAFETY CONSIDERATIONS

1. Propane is classified as a hazardous material. By law, a Material Safety Data Sheet (MSDS) must be available and accessible to all employees in the workplace or business by request wherever hazardous materials are transferred, stored, or used. An MSDS for propane is available from propane suppliers or distributors. A generic MSDS for propane is included as Appendix B of this manual.
2. Propane released to the atmosphere is combustible within its flammability limits. The point where propane is transferred must be at least 25 feet away from any source of ignition and at least 35 feet away from any metal grinding or oxy-welding operation.<sup>1</sup> All unauthorized persons (potential ignition sources) should be kept at least 25 feet away from any tank venting or discharge areas.
3. All releases of propane should be performed outdoors in a well-ventilated area, downwind and away from any buildings or premises that may be occupied. Controlled flaring—combustion using proper equipment and performed by qualified persons—may be appropriate in some cases. Other persons in the area should be advised to keep out of the release area to prevent introduction of unidentified and unanticipated sources of ignition.

Gas discharged under controlled conditions must be burned off under controlled conditions or captured and returned to an auxiliary tank for both safety and environmental reasons.

4. Propane is clear, colorless and odorless in its natural state. Propane is a non-toxic gas, but if inhaled in sufficient quantities, it may cause disorientation or ultimately, death due to displacement of oxygen. A man-made odorant, typically ethyl mercaptan, a sulfur-based compound, is added to propane prior to wholesale distribution. The odorant aids in the detection of a combustible mixture of air and fuel by a person with a normal sense of smell at 1/5 of the lower limit of flammability.
5. Since propane vapor is heavier than air, the greatest concentration of propane and combustible propane-air mixtures may initially be at ground level, even though the odor may initially be less detectable at higher levels or in surrounding areas.
6. Pressures may exceed 300 psig in a propane autogas fuel tank. The pressure varies with the temperature of the air around the tank and any other heat added from sources such as fuel pumps, recirculated fuel, vehicle exhaust systems, solar radiation or road surfaces.

When liquid propane is released to any pressure below the storage pressure, it expands, absorbing heat from its surroundings, and its temperature momentarily decreases. If

<sup>1</sup> NFPA 58, 2008 and 2011 eds.; §§7.2.3.2(B) and 7.2.3.2(C)

the pressure is allowed to drop to zero, propane will auto-refrigerate to its boiling point, which is 44 degrees below zero Fahrenheit ( $-44^{\circ}\text{F}$ ). Contact with liquid propane can cause immediate frostbite. Exposure to liquid propane must be prevented by wearing suitable protective clothing, including gloves and safety eyewear.

7. The use of personal protective equipment should be mandatory whenever installing or servicing a propane fuel system or tank.
  - Drilling, grinding, welding, and working under a vehicle can produce flying metal, dirt, and debris. Safety glasses are mandatory.
  - Safety standards for working with propane are covered in NFPA 58, *Liquefied Petroleum Gas Code*, as adopted by the authority having jurisdiction.

Special precautions must be used and maintained to prevent injury, including wearing protective gloves, safety eyewear and hearing protection.

## Review of Chapter 2 - Basic Safety Considerations

**Directions:** Select from the list below the response that most correctly completes each of the following statements. Write the letter of your choice in the space provided. Items shown in this list may represent information shown prior to Chapter 2.

- |                         |                                  |
|-------------------------|----------------------------------|
| A. unauthorized persons | E. Personal Protective Equipment |
| B. frostbite            | F. 25 feet                       |
| C. one fifth (1/5)      | G. non-toxic                     |
| D. MSDS                 | H. -44°F                         |

- \_\_\_ 1. Propane has an auto-refrigeration temperature (boiling point) of \_\_\_\_\_.
- \_\_\_ 2. Ignition sources must be eliminated within \_\_\_\_\_ of a propane-fueled vehicle work area.
- \_\_\_ 3. Released propane liquid can cause immediate \_\_\_\_\_ on exposed skin.
- \_\_\_ 4. Odorized propane should be detectable to a person with a normal sense of smell at \_\_\_\_\_ of the lower flammability limit.
- \_\_\_ 5. Employees involved in evacuating the engine fuel tank should use the appropriate \_\_\_\_\_.
- \_\_\_ 6. All \_\_\_\_\_ must be kept away during propane tank venting procedures.
- \_\_\_ 7. Propane vapor is \_\_\_\_\_ if accidentally inhaled in small quantities.
- \_\_\_ 8. The document that provides propane chemical safety information for employees is the \_\_\_\_\_.

*Answers: 1-H, 2-F, 3-B, 4-C, 5-E, 6-A, 7-G, 8-D*

**IMPCO®**



# Chapter Three

## ***IMPCO/BRC Sequent Plug and Drive Multi-Port Vapor Fuel Injection***



## CHAPTER 3: IMPCO/BRC SEQUENT PLUG AND DRIVE MULTI-PORT VAPOR FUEL INJECTION

The IMPCO/BRC Sequent fuel system is designed to operate in series with the original gasoline fuel system. The gasoline fuel system remains 100 percent operational and is not influenced in any way by the propane autogas fuel system. To comply with EPA and CARB certification requirements, the autogas fuel system must be fully transparent to the gasoline fuel system when operating in gasoline mode.

The Sequent system begins at the high-pressure fuel lock-off at the vaporizing regulator. The system installer may have installed additional components that are not provided by IMPCO/BRC.

**Items marked with an asterisk are NOT IMPCO/BRC and will not be discussed in this chapter.**

- \*Fuel tank
- \*Fill connector
- \*High-pressure fuel lines
- Vaporizer / pressure regulator
- Fuel lockoff solenoid
- Fuel filters, low and high pressure
- Low-pressure fuel lines
- Fuel injectors
- Fuel metering nozzles
- Gas temperature and pressure sensor (located on the fuel rail)
- Coolant temperature sensor (combined with the vaporizer regulator)
- Manifold Absolute Pressure (MAP) sensor

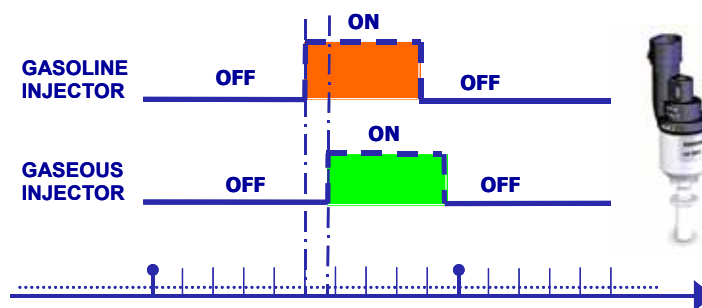

Figure 9. Injector shift value



## *IMPCO/BRC Sequent Plug and Drive Multi-Port Vapor Fuel Injection*

The Sequent fuel system determines optimum air-fuel mixtures by using manifold vacuum, engine RPM and engine displacement to calculate engine load. These calculations set the “shift value” for autogas operation—i.e., they determine the difference between the injector pulse width for autogas and the pulse width for gasoline.

The Sequent system uses these “speed density” calculations to determine the shift value needed to adjust for injecting propane autogas vapor instead of liquid gasoline. This adjustment occurs even when the OEM fuel system uses mass air flow (MAF) calculations. The system reads the values calculated for gasoline from the OEM fuel-trim tables and adjusts the injectors’ start time and on-time to optimize for the density, volume and octane rating of autogas vapor.

### **3.1 System Overview**

The Sequent fuel system automatically defaults to gasoline in the event of major component failure that forces the fuel system out of its designed or programmed limits. These conditions include, but are not limited to:

- **Loss of electric power.** This may occur due to a loss of ground or 12V reference. The normally closed relays that control the fuel injectors are located inside the Sequent PCM. If the injector relays are not energized, they default to the gasoline mode.
- **Unplugged PCM.** If the PCM is unplugged, it will not operate on either fuel (see above). The gasoline fuel injectors are wired through the PCM.
- **Unplugged sensor.** If any of three additional sensors are electrically unplugged, the system will revert to gasoline. The sensors are:
  - MAP sensor
  - Gas pressure sensor
  - Vaporizer coolant temperature sensor
- **Excessive throttle opening or engine demand.** The system may default to gasoline if the engine is not at full operating temperature. The default to gasoline occurs to prevent damage to the exhaust system’s catalytic converter.

Each of these components requires a unique diagnostic sequence. It is often helpful to begin a series of diagnostic steps starting where the fuel is stored. Each step should be completed in sequence to isolate the possible failed component.

### 3.1.1 No operation on autogas

*Driver Comment: “The vehicle won’t run on propane.”*

The technician should always verify the fuel level in the tank before attempting to diagnose a non-operable condition.

This step must be performed AFTER validating the vehicle’s operation on gasoline. Follow standard diagnostics to isolate the gasoline operation. These steps include, but are not limited to, ignition primary signal, crank position signal, injector signal, fuel pressure, battery and cranking voltage.

If the vehicle will not operate on gasoline or autogas, perform the gasoline diagnostic steps first. The “no-start on gasoline” condition may be accompanied by a Malfunction Indicator Lamp on the dash. Resolve any gasoline-related faults before proceeding with other diagnostics.

In many cases, a no-start or no-run condition may be simply traced back to a lack of fuel. To verify, carefully open the 80 percent fixed maximum liquid level gauge on the autogas tank to confirm that there is pressure available at the tank. Note that some vehicles have a remote-fill location that pairs the fill connection and the 80 percent fixed maximum liquid level gauge. If pressure is present when the 80 percent fixed maximum liquid level gauge is opened, enough fuel should be present to run the engine.



Figure 10. Fixed maximum liquid level gauge

In addition, a fuel pressure sensor on the fuel injector rail prevents the vehicle from running if fuel pressure is too low for proper vehicle operation. The Sequent fuel system requires a minimum of 12 psig (750mbar) to operate. If fuel pressure is below that level, the vehicle will automatically revert to gasoline mode to prevent a lean air-fuel mixture from damaging the exhaust catalyst. This condition might occur if the secondary fuel flow or pressure is restricted or the fuel tank is nearly empty.

If in doubt, add a small amount of propane autogas to the tank and retest.

**Note:** The fuel gauge on the tank is an approximation of the fuel level and should not be used to validate the actual fuel level.

**Note:** If fuel is present in the tank, but fuel pressure is outside the system’s design limits, the system will not switch over to propane autogas.

**Note:** See the following section to determine if there is an electrical fault in the Sequent fuel system.

### 3.1.2 Fuel identification

*Driver Comment: “I can’t tell which fuel I’m using.”*

#### **Explain the automated changeover process**

The technician should verify that the operator is waiting long enough between starting the vehicle and observing a switch-over to propane.

A vehicle with a properly operating propane autogas fuel system will perform almost transparently to gasoline. Vehicle operators may not be able to easily distinguish the difference between the two fuels.

The Sequent system starts on gasoline by design. Then, when certain conditions are met, the vehicle automatically switches over to autogas. This ensures that any autogas in the vaporizer is in vapor form and not a partially atomized mist. As discussed in Chapter 1, propane expands in volume 270 times as it changes from liquid to vapor. Any liquid or partially vaporized propane, close to the saturation line, will be many times denser than propane vapor. When metered into the engine, fuel in this partially vaporized state will drastically alter the air-fuel ratio during cold starting and may cause irreparable damage to the exhaust catalytic converter or the fuel injectors.

This problem is solved by starting the engine on gasoline and then automatically switching over to propane autogas when the engine coolant reaches operational temperature

It is important to remember that the electrical selector switch located on the dash is also a diagnostic tool. The proper name for this selector switch is the “Fuel On Indicator Lamp” or “FOIL.”

The red LED will be illuminated whenever the vehicle is operating on gasoline. If the first green LED is NOT illuminated, the vehicle will not switch over to propane autogas. If the first green LED IS illuminated, the vehicle WILL switch over to autogas. The vehicle operator or diagnostic technician should observe the transition and the LED light colors for assistance in addressing the driver’s comments.

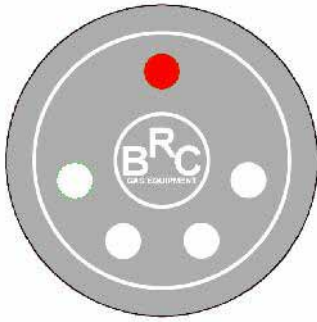

The red LED will be illuminated when the vehicle is running on gasoline. If the left green light is NOT on, the vehicle will not switch to propane autogas.

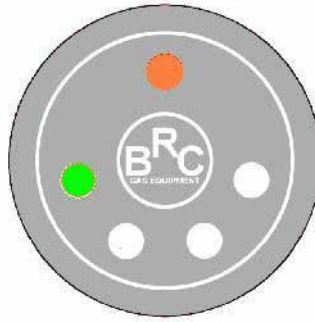

The amber LED will be illuminated when an automated transition between gasoline and autogas is in progress.

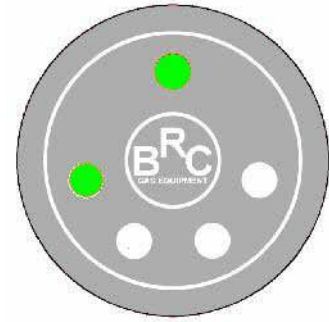

The green LED will be illuminated when the transition is completed and the vehicle is operating on autogas.

Figure 11. Fuel On Indicator Lamp (FOIL)

The Sequent system requires three conditions to be met before the vehicle will switch over automatically from gasoline to autogas: time, temperature and fuel pressure. The system cannot be forced to switch to autogas if these conditions are not met.

- 1. Time.** If the FOIL selector switch is set to run on autogas, every engine start sequence will always begin with gasoline and switch over in as little as two to five seconds when hot, or take as long as 4-5 minutes if ambient temperatures are very cold.
- 2. Temperature.** The temperature is measured in two places, at the vaporizer and at the fuel rail pressure transducer. The sensor at the vaporizer shows the engine coolant temperature. The sensor at the fuel rail pressure transducer shows the temperature of the vaporized propane.

The Sequent fuel system requires engine coolant temperatures to be above 35°C (95°F) on a cold start, or 45°C (113°F) on a hot restart. If the fuel pressure is below approximately 40 psig, the fuel system may not automatically switch over. Verify that the ambient temperature is above -10°F to ensure sufficient vapor pressure at the tank. If the ambient temperature is below approximately 0°F, there may not be enough pressure available at the fuel tank to supply the regulator.

- 3. Fuel pressure.** Fuel pressure is measured at the fuel filter pressure transducer. If the fuel rail pressure is below approximately 11 psig or 750 mbar, the engine will not operate on propane autogas even if the other conditions are met.

**Note:** If the red LED light on the FOIL switch is NOT illuminated, the vehicle will default to gasoline. Verify the Sequent power fuse and ground circuit.

### 3.1.3 Gasoline consumption

*Driver Comment: “The vehicle keeps using gasoline while operating on autogas.”*

#### **Explain the Sequent starting process.**

The Sequent fuel system always starts on gasoline. Depending on the ambient temperature, the automated switchover process may take as long as 5 minutes. During this time, gasoline is still being used. It is important to remember that the gasoline tank should be kept at least one-fourth to one-half full to minimize moisture condensation, and that the vehicle should NOT be allowed to run out of gasoline. Gasoline fuel pump damage can occur.

Operation on gasoline also maintains the emissions requirements of the EPA certificate of conformity. In this case, the gasoline tank canister purge sequence is activated to remove any remaining vapors from the gasoline tank.

Depending on the application, the gasoline fuel pump may continue to operate even while the system is running on autogas. This continual operation keeps the gasoline circulating and helps prevent the buildup of partially vaporized gasoline in the fuel rails and fuel injectors. The continual operation also allows for a smooth transition between autogas and gasoline by keeping the gasoline in the fuel injectors fresh and pressure primed.

Depending on the number of starting cycles, as much as 10 percent of total fuel consumption may be gasoline, or as little as 2 percent if the vehicle is driven primarily on the highway.

**Note:** If the FOIL switch is manually changed to gasoline while in operation, the vehicle will restart on gasoline and stay running on gasoline until it is manually switched back over to autogas. The vehicle will always start on the fuel that was last selected.

**Note:** If the vehicle is operated in very cold climates, the initial and subsequent starting cycle switchover times will be extended. During this time, the vehicle will use gasoline.

### 3.1.4 No automatic switch to autogas

*Driver Comment: “The vehicle doesn’t automatically switch over to autogas.”*

**The technician must verify that there is sufficient fuel in the tank.**

**If the red LED on the FOIL switch is NOT illuminated:**

The first step should be to see if there is a red LED at the FOIL switch. This verifies that there is electrical current to the Sequent PCM. If the red LED is NOT illuminated, the system will default to gasoline. Verify that the 12-volt inline fuse near the battery is intact and that the Sequent wiring has not been altered by a third-party radio or other electrical accessory installer.

**If the red LED on the FOIL switch IS illuminated:**

Next, while operating in gasoline mode, depress and release the center button on the FOIL switch. A beep should be heard, signifying that the changeover is in progress. Also at this time, a green LED should be seen at the leftmost of the four LEDs in the lower part of the FOIL. This also means that the transition to autogas is in progress. Within a few moments, the red LED should change to amber, then to green.

If the red LED is illuminated AND the left green LED is illuminated and flashing, the vehicle may be out of fuel and has reverted back to gasoline. A diagnostic trouble code (DTC) will be stored in the Sequent PCM. The stored DTC will probably reference a low fuel-pressure value. This is a hard code that requires the vehicle to revert back automatically to gasoline.

After the technician has verified that there is fuel in the tank, the next item to inspect is the fuel pressure transducer located on the fuel rail. Verify that the transducer is plugged in and that the wiring is not damaged.

#### Transducer specifications

- Connector Color: Brown
- Supply Voltage: 5V
- Pressure Sensor Output: 0 – 5V
- Temperature Sensor Range:  $-40^{\circ} - 130^{\circ}\text{C}$  ( $-40^{\circ} - 266^{\circ}\text{F}$ )
- Installation Torque: 11-15 ft-lbs (15-20 Nm)
- Temperature Sensor Resistance Values (Figure 13):



Figure 12. Transducer

## IMPCO/BRC Sequent Plug and Drive Multi-Port Vapor Fuel Injection

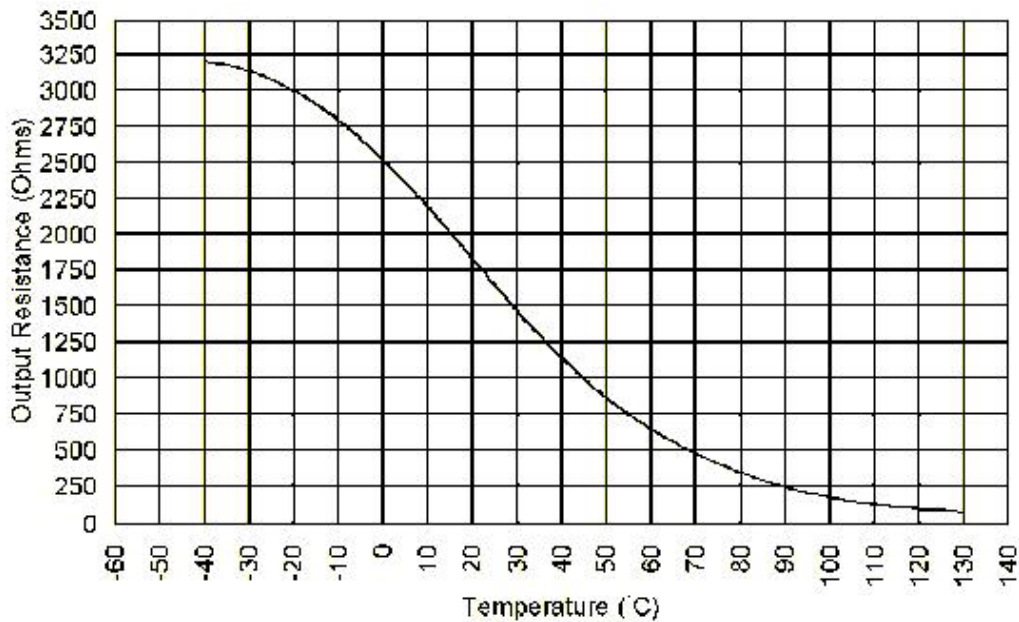

Figure 13. Transducer resistance chart

If the red LED does NOT transition to amber and to green, or if the green LED at the lower left does NOT illuminate, a malfunction is indicated in the Sequent system and connection to the Diagnostic Program is required.

See Accessing the Sequent Diagnostic Program, p. 39.



### Warning

If the LED lights at the FOIL switch rotate around in a circle, the PCM is damaged and should be returned for inspection. The vehicle will NOT run on gasoline with the PCM disconnected.

## 3.1.5 No manual switch to gasoline

*Driver Comment: “The vehicle has quit running on autogas, and I can’t manually switch over to gasoline.”*

If the operator has allowed the vehicle to run out of autogas AND gasoline, the vehicle will not start.

If the red LED and the green LED are both blinking, there should be a stored DTC. The technician must verify that there is fuel in the autogas tank. A malfunction is indicated in the Sequent system, and connection to the Diagnostic Software Program is required. See Accessing the Sequent Diagnostic Program, p. 39.

See the following “Driver’s Comment” for additional information.



### 3.1.6 Automatic fuel switch during acceleration

*Driver Comment: “I had to accelerate at full throttle on autogas. Now the vehicle has switched over to gasoline and the FOIL lamp is blinking and beeping. It wouldn’t switch over to autogas until I turned the engine off and restarted.”*

**Note:** This problem will be more pronounced when the outside temperature is very cold.

If the driver tries to accelerate hard when the vehicle has just transitioned from gasoline to autogas, the engine coolant may be at borderline operating temperature. The sudden rush of fuel into a moderately warm vaporizer may temporarily chill the vaporizer below its switching threshold (35° to 45°C), which will force an automatic switchover to gasoline.

The vehicle will automatically switch to gasoline to prevent an erratic fuel mixture (partially vaporized liquid autogas) from damaging the catalytic converter. The FOIL lamp and buzzer warning indicate that this has happened. A DTC may have been stored indicating low fuel pressure or low vaporizer temperature.

### 3.1.7 Gradual loss of power

*Driver Comment: “The vehicle gradually lost power while operating on autogas. The power loss became progressively worse. The vehicle then automatically switched to gasoline and can’t be switched back to autogas”*

#### Possible cause #1

The probable cause is a restricted fuel filter. The system has two filters. If the flow of fuel is sufficiently restricted through either of these filters, the fuel-rail-mounted pressure transducer will detect the loss in pressure and will command a low-pressure DTC that forces an automatic return to gasoline operation. This prevents an excessively lean fuel mixture from damaging the catalytic converter. The red LED and the green LED will be blinking, indicating a stored DTC.

The fuel filters should be replaced annually, or at 15,000 miles, as indicated in the owner’s manual.



**Figure 14. Primary (liquid) filter.** The primary or liquid filter is directly below the fuel solenoid, just behind the hose indicated by the red arrow. It may be serviced on the vehicle.



**Figure 15. Secondary (vapor) filter.** The secondary or vapor filter is located in the low-pressure hose between the vaporizer and the tee that feeds the two injector rails. It may be serviced on the vehicle.

The primary filter is replaced by first closing the manual valve on the fuel tank and running the engine until it either quits running or switches over to gasoline. Attempt to restart to ensure that all autogas pressure is depleted.

#### Tools Needed

- 15mm wrench (access room will dictate which type of wrench will work best)
- 14mm wrench (access room will dictate which type of wrench will work best)
- O-ring lubricant or automatic transmission fluid

## IMPCO/BRC Sequent Plug and Drive Multi-Port Vapor Fuel Injection

Using a 15mm wrench, remove the lower cover bowl of the filter. Then remove the 14mm retaining bolt for the filter support shaft. Replace the filter, the support shaft, and then the cover bowl.

The lockoff solenoid specifications are as follows:

- Operating Temperature Range:  $-20^{\circ}\text{C} \sim 120^{\circ}\text{C}$  ( $-4^{\circ}\text{F} \sim 248^{\circ}\text{F}$ )
- Maximum Working Pressure: 3000kPa (435.1 psi)
- Operating Voltage: 6V ~ 16V
- Coil Resistance:  $9.2\Omega \sim 9.5\Omega$  @  $15^{\circ}\text{C} \sim 25^{\circ}\text{C}$  ( $59^{\circ}\text{F} \sim 77^{\circ}\text{F}$ )
- Serviceable Filter (Part # 04RE00100005): Replace at 15,000-mile intervals.



### Caution

Do not operate the fuel system without both filters in place. Damage that is not covered under warranty may occur to the vaporizer and/or fuel injectors.

The secondary filter is replaced by carefully removing one of the canister's snap rings with internal snap ring pliers and withdrawing the canister end cap. The end cap is sealed by an O-ring which may become dislodged. The O-ring typically will become swollen with residual oils from the fuel and should not be reinserted into the canister. The replacement fuel filter will come with two sets of O-rings.

Replace the fuel filter by pulling it from the filter canister and reinserting the new filter. Lubricate the new O-ring with O-ring lubricant or a few drops of SAE 30 motor oil or automatic transmission fluid. Reinstall the O-ring in the canister groove and press the end cap back into place. Secure with the snap ring.

The pleated paper filter may be cut open to determine the contents causing any possible restriction.

### Possible cause #2

IMPCO/BRC diagnostic software must be used to determine if a vaporizer pressure fault exists (i.e., outlet pressure too high or too low). The Sequent fuel system requires a minimum of 750mb (12 psig) to operate. If the pressure is outside acceptable limits, the fuel system will default to gasoline.

### 3.1.8 Out of gasoline

*Driver Comment: “The vehicle ran out of gasoline and won’t start.”*

This condition may occur if the driver forgot to fill the gasoline tank or if an automated fleet-management system prevented the gasoline tank from being filled completely due to fuel-usage policies.<sup>1</sup>

#### **Explain the fuel usage requirements of the Sequent system.**

The IMPCO/BRC Sequent system can be force-started on autogas.

#### **Emergency starting in autogas mode ONLY:**

If the vehicle runs out of gasoline or has a gasoline fuel-delivery problem that will not allow the engine to run on gasoline, the operator can force the engine to start and run on autogas up to five times.

To start the engine in autogas mode:

1. Turn the ignition ON, engine OFF.
2. Depress the changeover switch until 2 beeps are heard (about 4 seconds)
3. Start the engine within 4 seconds
4. Release center button



**Figure 16. Changeover (FOIL) switch**

Each false start counts as a start sequence, even if the vehicle does not start. If the engine is not started in 4 seconds, the force start sequence must be re-initiated.

Remember that the engine can only be restarted on autogas a total of five times and can ONLY be reset by the Diagnostic Program, through the “ECU Version” screen. The number of forced starts will be recorded until erased through the Diagnostic Program.

<sup>1</sup> Some automated fleet-management systems or policies may allow only a fixed amount of gasoline to be used in a specific period, e.g., 5 gallons per week or month, or 10 percent of the total fuel used per refill, to encourage the use of alternative fuels.

### 3.1.9 No operation after refueling

*Driver Comment: “I just refueled on gasoline, and now the vehicle won’t run properly (or won’t run at all) on autogas”*

The technician should verify that this problem sequence is exactly as described and that the vehicle ran normally until this event occurred.

The technician should verify that the driver did NOT refuel with E-85, which is a mixture of 85 percent ethanol and 15 percent gasoline.

Many current vehicles are flex-fuel, meaning they can operate on mixtures of ethanol and gasoline in any proportion. When a flex-fuel vehicle is converted to autogas with a Sequent fuel system, the vehicle may use only gasoline that contains up to 10 percent ethanol. To maintain its ability to use autogas, the vehicle should not be operated on E-85.

The Sequent fuel-management system uses the original gasoline fuel system’s injection calculations. Any alteration to those calculations may cause the autogas system to go out of calibration.

The reason is that E-85 falls outside the fuel-mapping limits of the Sequent PCM. The original vehicle’s oxygen sensor feeds back information on the exhaust composition to the original PCM. When the vehicle has been fueled with E-85, the gasoline program that was stored in the original PCM is too lean for E-85 operation. The oxygen sensor detects the lean exhaust mixture and allows the adaptive memory tables in the Sequent PCM to modify the gasoline fuel programming to recognize the fuel mixture until it achieves the proper stoichiometric mixture for E-85.

This can be recognized by observing the Short Term Fuel Trim (STFT) values with an OBD-II scan tool. Standard OBD-II adaptive-learn policies typically limit adaptive fuel trimming to approximately 25 percent to 35 percent lean or rich from the “0” value, also called the “threshold limit.” E-85 expands the threshold limit to as much as 50 percent. This expansion is outside of the Sequent’s EPA-certified fuel-mapping range. The industry calls this “active fuel management,” which means that the vehicle’s PCM is always monitoring the fuel-system inputs and controlling the fuel mixture for optimum performance and emissions.

If a flex-fuel vehicle is inadvertently filled with E-85, the recommendation is to operate the vehicle solely on E-85 until the tank is depleted, then run one full tank of regular unleaded 87-octane gasoline containing no more than 10 percent ethanol before switching back to autogas, to allow the gasoline PCM to recalibrate itself to the autogas-adaptable program.



## **Caution**

If the vehicle is not E-85 capable, E-85 fuel must be removed immediately to prevent permanent damage to the fuel tank, fuel pump, fuel injectors and fuel-pressure regulators. The vehicle should then be immediately refueled with unleaded gasoline and operated for one full tank without switching over to autogas.

### 3.1.10 Inaccurate fuel level gauge

*Driver Comment: “My dashboard gauge doesn’t read the autogas fuel level accurately.”*

The technician should explain that the fuel-level gauge on an autogas tank is not a true representation of the fuel level inside the tank and should not be used during refueling or to calculate fuel consumption.

The fill level inside an autogas fuel tank is measured with a float that operates a magnetically coupled dial gauge mounted outside the tank. Attached to that dial gauge is a variable transducer or resistor that is designed to replicate the original dash gauge, if used. Other vehicle installations may utilize the LED lights on the fuel selector switch as the fuel level gauge, with each light indicating  $\frac{1}{4}$  tank level increments.

The Sequent fuel system switches from autogas to gasoline at a pre-programmed point. This point is determined in part by the gasoline fuel-level gauge, which typically plays a part in the OEM vehicle’s emission-control strategy by correlating fuel consumption with canister purge sequencing. For this reason, the Sequent PCM is programmed to require at least one fuel-level LED to remain illuminated on the FOIL switch while the vehicle is running on autogas.

The volume of liquid autogas is also sensitive to temperature. From a reference point of 60°F, propane expands or contracts about 1 percent for every 6°F increase or decrease in temperature, respectively. If a tank is filled during a hot day and the level observed that night after the weather turns cold, the fuel level can be significantly different. During the fall and spring outside temperatures can vary as much as 40°F, which can result in a 6 percent change in fuel volume and a corresponding change in the level of fuel in the tank.

When the vehicle starts on gasoline, the OEM dash fuel gauge automatically reads the gasoline level. As the vehicle transitions to autogas, the OEM dash fuel level gauge may slowly transition to indicate the autogas fuel level. This transition may take 30 minutes or longer. When the vehicle returns to gasoline operation, either by automatic or manual switchover, the gauge again transitions slowly to indicate the gasoline fuel level. The dash gauge movement is buffered because the original PCM sets the charcoal canister purge sequencing and duration based on the fuel level.

## 3.1.11 Check engine light

*Driver Comment: “My check engine light came on, but the vehicle seems to be running normally. What’s wrong?”*

First, never assume that a dashboard indicator light means there is a fault in the autogas fuel system, even though the diagnostics are integrated. The check engine light (also known as an MIL or Malfunction Indicator Light) can be triggered by a number of vehicle faults, including in some cases improper tire size (which might trigger an ABS fault), low tire pressure, overheated catalyst, inoperable cooling fan, loose gas cap, defect in the canister purge sequence, over-rev or over-speed, or engine misfire.

The first step to isolate the problem is to connect the OBD-II scan tool and observe the diagnostic codes.

### First Digit - System

The first character identifies the system related to the trouble code:

- P = Power train
- B = Body
- C = Chassis
- U = Undefined

### Second Digit - Code Type

The second digit identifies whether the code is a generic code (same on all OBD-II equipped vehicles), or a manufacturer-specific code:

- 0 = Generic (this is the digit zero, not the letter “O”)
- 1 = Enhanced (manufacturer-specific)

### Third Digit - Subsystem

The third digit denotes the type of subsystem that pertains to the code:

- 1 = Emission management (fuel or air)
- 2 = Injector circuit (fuel or air)
- 3 = Ignition or misfire
- 4 = Emission control
- 5 = Vehicle speed & idle control



## ***IMPCO/BRC Sequent Plug and Drive Multi-Port Vapor Fuel Injection***

- 6 = Computer & output circuit
- 7 = Transmission
- 8 = Transmission
- 9 = SAE reserved
- 0 = SAE reserved

### **Fourth and Fifth Digits**

These digits, along with the others, are variable, and relate to a particular problem. For example, a “P0171” code means P0171 - System Too Lean (Bank 1).

The most likely Generic OBD-II codes that could related to autogas operation are:

- P0171 system too lean (bank 1)
- P0172 system too rich (bank 1)
- P0173 fuel trim malfunction (bank 2)
- P0174 system too lean (bank 2)
- P0175 system too rich (bank 2)

These codes might indicate a fault that, if autogas-related, may be stored in the Sequent PCM. Remember that the Sequent PCM reads the original vehicle PCM. Any codes caused by either fuel system will be stored in the vehicle PCM (i.e., any codes that are NOT specific to the Sequent.)

These are manufacturer-specific OBD-II codes that the Sequent system utilizes:

- P1105 - MAP SENSOR (MIN/MAX=59/4950 multivalve)
- P1115 - TH2O SENSOR (@ REGULATOR) (MIN/MAX=300/4500multivalve)
- P1180 - TGAS SENSOR (MIN/MAX=150/4500multivalve)
- P1190 - PGAS SENSOR (MIN/MAX=59/4945 multivalve)
- P1201-P1208 - SEQUENT GAS INJECTORS 1-8 CONTROL
- P1230 - ACTUATORS RELAY CONTROL
- P1231 - FRONT LOCKOFF CONTROL
- P1232 - REAR LOCKOFF CONTROL
- P1335 - RPM OR CKP SENSOR (MIN/MAX=200/7600 RPM)
- P1460 - GAS LEVEL INPUT
- P1560 - BATTERY VOLTAGE (MIN/MAX=6/17.5V)
- P1608 - 5V REFERENCE VOLTAGE (MIN/MAX=4/6V)
- P1649 - CAN LINE (OEM fault code set – check OEM ECU with OBD-II scan tool)
- P1650 - CHANGEOVER SWITCH
- P2531 - KEY CONTACT

## 3.1.12 Special spark plugs

*Driver Comment: “I was told to use special spark plugs. Why is that required and how often should I change them?”*

Unless specially identified in the EPA or CARB emission certificate of conformity, the only spark plugs installed should be those originally specified by the OEM.

In early autogas vehicle conversions, spark plugs were frequently gapped closer than the OEM plugs to help prevent backfires. Since spark plugs with a smaller gap do not require as intense a secondary ignition current, the ignition coils would last longer, and before distributors and distributor caps became obsolete, they would last longer, too. Current coil-over spark ignition systems have a stronger secondary ignition that can easily ignite autogas fuel mixtures.

The Sequent-managed autogas fuel mixture is closely matched to the original gasoline fuel mixture and is less demanding on the ignition system than early mechanical carbureted autogas systems. Since the fuel system must be EPA-certified to an emission standard that is at least as clean as the original vehicle, the fuel mixtures stay in closer trim for a longer period.

Older autogas aftermarket conversion facilities also changed the spark plugs from platinum tip or iridium tip to copper core; however, no conclusive tests have shown that any spark plug is superior to the one that was originally installed. Changing from these premium spark plugs to a copper-core spark plug may also shorten the plug change interval from as high as 100,000 miles to less than 25,000 miles in some cases.

## IMPCO/BRC Sequent Plug and Drive Multi-Port Vapor Fuel Injection

### 3.2 Accessing the Sequent Diagnostic Program

Go to [www.impcoautomotive.com/index.php?pagename=sequent-tech](http://www.impcoautomotive.com/index.php?pagename=sequent-tech).

At the login screen, enter the username as “Sequent” and the password as “dualfuel”. Download the files to a desktop folder and extract.

The file needed is: “SequentPD\_Ver.3.00”.

**Note:** This file may be updated periodically. The technician should access this web site periodically and download the most recent file. Administrator access may be required to install this program on a laptop.

Communication with the Sequent PCM is accomplished by a proprietary diagnostic cable.



Figure 17. Required USB cable: #DE512222



Figure 18. Diagnostic connector secured to coolant overflow bottle

Once the program is installed and the cable plugged in, verify that there is a valid USB connection and rectify if needed.

Initialize the Sequent Diagnostic Program by clicking on the desktop icon. The following screen should be seen:

**Note:** All Sequent Plug & Drive screen shots and “blue sky” images are provided by IMPCO/BRC, which retains sole responsibility for their content and accuracy.



Figure 19. Sequent Plug & Drive home screen

Key:

- #1. This is the only way to exit the program. The Windows controls at the top right allow users to minimize and maximize the screen, but not to close the program.
- #2. This is the software version number, which should be recorded on the vehicle's worksheet.
- #3. Clicking this graphic opens a small window that identifies the full software version information.
- #4. See #1 above.
- #5. This window shows the communication speed, or if the link is lost, shows no communication.
- #6. Software type, P&D (plug and drive)
- #7. Any active diagnostic faults stored in the Sequent system will be displayed here. Any active codes will turn this window red, with the number of errors clearly displayed:

**DIAGNOSTIC ENABLED (2 ERRORS)**

## IMPCO/BRC Sequent Plug and Drive Multi-Port Vapor Fuel Injection

When the “DIAGNOSTIC” button is clicked, this window opens:



Figure 20. Diagnostic screen

The DIAGNOSTIC screen displays the following options (clockwise from top right):

- Data Visualization
- Errors Diagnostic
- Actuators
- ECU Version

Clicking on the Errors Diagnostic button shows this window:

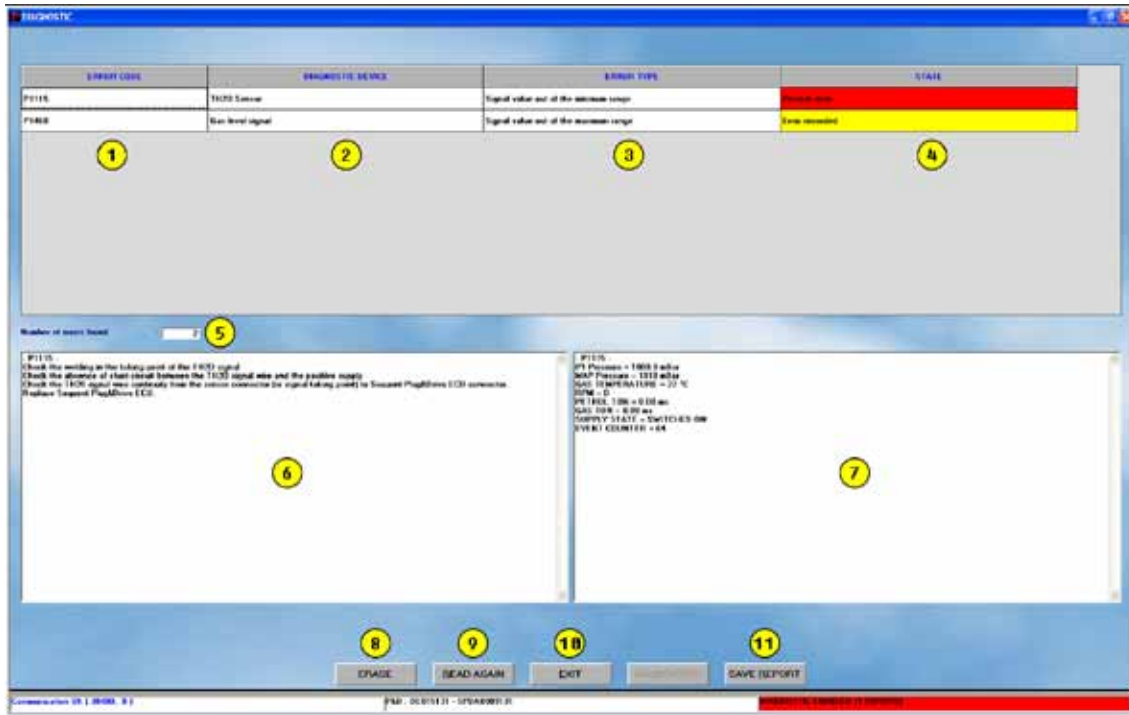

Figure 21. Errors Diagnostic screen

- Shows error codes stored
- Simple description of the faults
- Shows errors, typically above maximum or below minimum values
- Active Fault:** “Present Error” on red background. This is similar to a “Hard Code” familiar to most technicians. **Historic Fault:** “Error Recorded” on yellow background. This is similar to a “Soft Code” familiar to most technicians.
- Number of errors found
- Diagnostic Recommendations Field: This is the list of recommended checks to help find the cause of the reported problem. Start your diagnosis at the top and work down the list.
- Associated Context (Freeze-Frame Data) Field: This is the list of conditions present when the fault was recorded.
- Erase button. This button erases all current error codes and history codes.
- Read Again. Refreshes the current screen
- Exit. Exits from this screen to the previous screen
- Save Report. Saves the report to a text file for future review

## IMPCO/BRC Sequent Plug and Drive Multi-Port Vapor Fuel Injection

Returning to the main menu allows another diagnostic program to be selected. Select “Data Visualization.”

The Data Visualization screen provides a multiple input-output screen that resembles contemporary diagnostic equipment.



Figure 22. Main menu on home screen

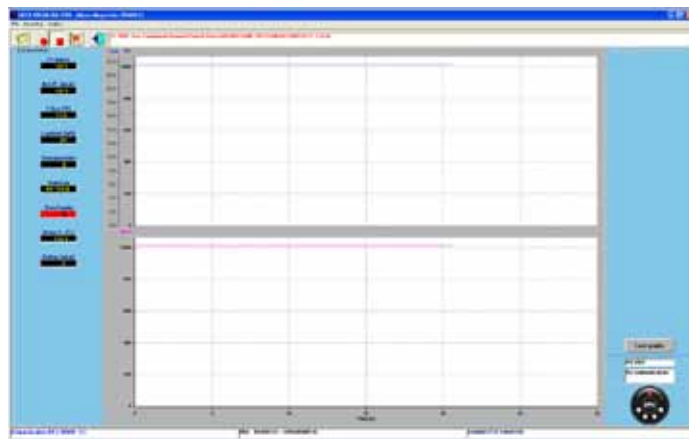

Figure 23. Data visualization screen

This screen shows the actual voltage and pressure readouts of all of the sensors that are monitored on the engine. It also monitors the OEM vehicle PCM through the CAN-BUS link.

- “Recording parameters” sets up the name of the flight recording
- F1 Starts and restarts the recording
- F2 Ends the recording
- F3 Locks the graphs (freeze frame)
- Exit, returns to initial screen

Right-clicking on the left side blue border activates a menu selection for placement in the blue border. Readouts are digital. Up to 15 test items may be selected.

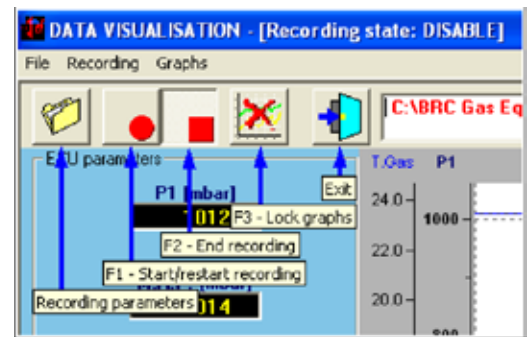

Figure 24. Recording parameters

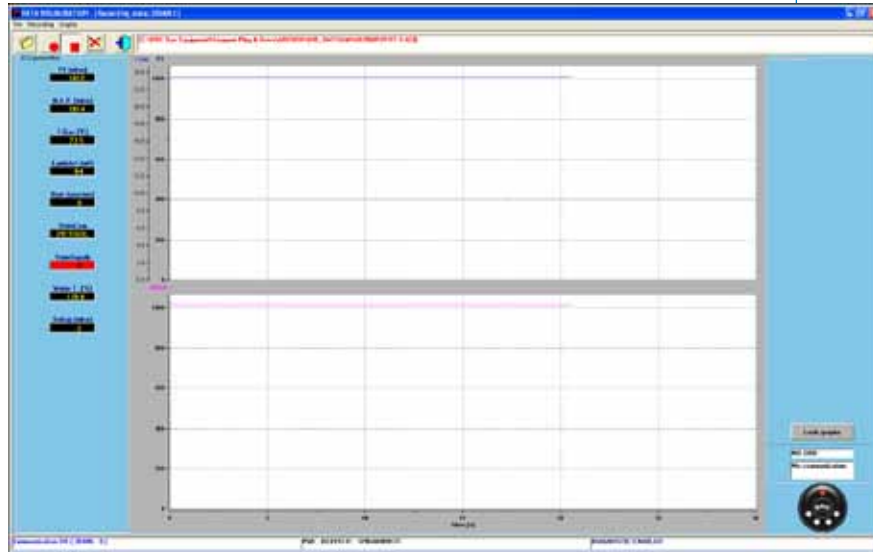

Figure 25. Blue navigation bar showing user-selectable displays

At the bottom right of the screen is an image of the FOIL switch. This switch is fully functional by either clicking on the button with the computer mouse, or by depressing the F5 keyboard shortcut key. These actions will cycle the vehicle from autogas to gasoline, and back again.

At the page top menu, the “GRAPH” selection on the menu bar will allow selection of up to three graph screens. Right-clicking in each of the white graph fields allows for individual graph selection. It is recommended that no more than three selections per graph be actuated, as it tends to crowd the graph. The line traces are small and hard to see.

Freezing the graphs opens the Graph Manipulation Tool Bar:

- Crosshairs
- Zoom In/Out
- Zoom Out All
- Pan
- Save Image
- Export Data
- Print Chart

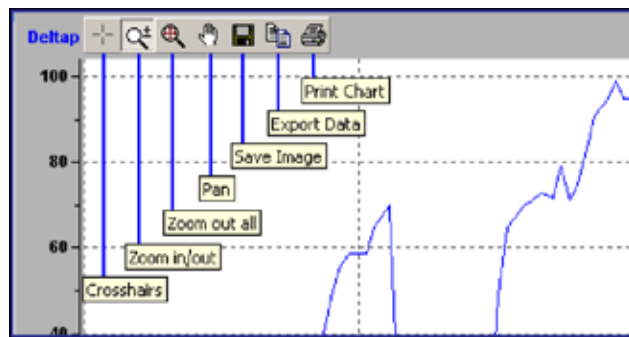

Figure 26. Graph manipulation toolbar



## IMPCO/BRC Sequent Plug and Drive Multi-Port Vapor Fuel Injection

### 3.2.1 OBD-II parameter readouts

Right-clicking in the right blue border of the data visualization screen activates the OBD-II parameters. When the OBD connections are established, the digital readouts will appear in the right side of the screen. These parameters can be displayed and graphed the same as the Sequent parameters by right-clicking in the white areas.

At the bottom of the graph selection is the OBD-II selection in the screen. It is helpful to have two graphs in operation. The Sequent readouts may be selected in the top graph, and the OBD-II readouts may be selected in the bottom graph.

If more than three selections are activated per screen, the screen update becomes erratic due to the increased data transfer requirements.

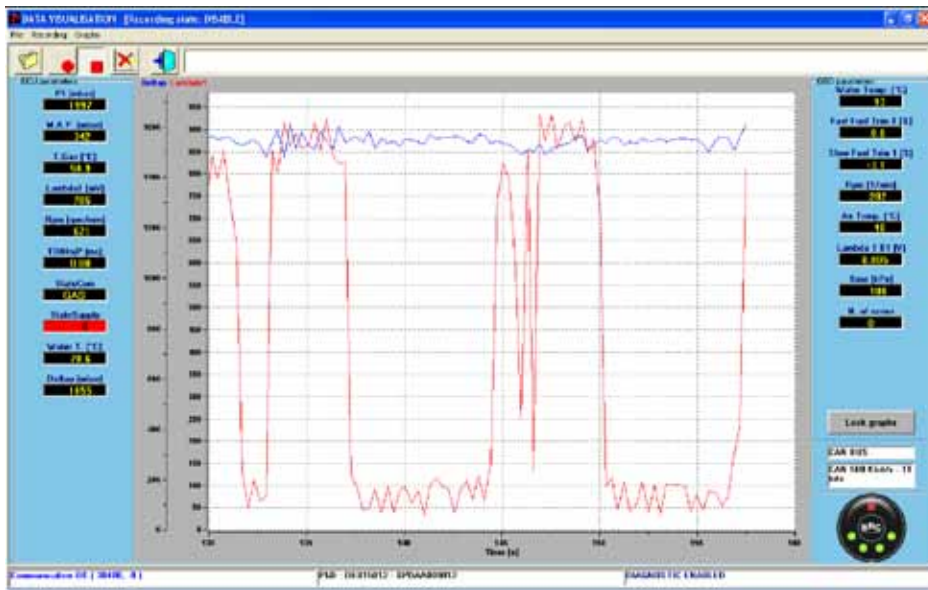

Figure 27. Parameter displays

At the lower right corner of the screen, the CAN-BUS has been enabled showing the data communication baud rate (500 Kbit/s in this example).

Click on the Exit button to return to the initial screen.

Clicking on the Actuator Test button actuates the individual injectors, solenoids, etc.

Portions of this particular diagnostic sequence should only be performed with the engine off and the key in the on position.



Figure 28. Actuator Test button on home screen



Figure 29. Actuator screen with injector and solenoid test buttons

This screen allows for the manual operation of each fuel injector while the engine is running (KOER), and in the bottom part of the screen as separated by the gray line, and should only be actuated with the engine turned off with the key on (KOE0).

Each fuel indicator LED can be activated along with the FOIL buzzer. Each injector will be dry-fired approximately once per second. EV ANT and EV POST mean “Electro Valve Front” and “Electro Valve Rear.

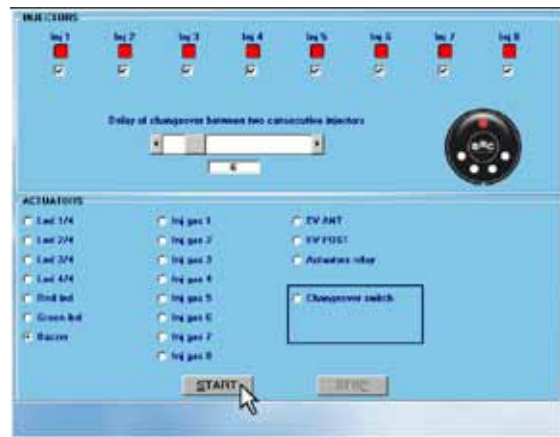

Figure 30. Start test button on actuator screen

### **3.2.2 Actuator testing**

**CAUTION:** Do not activate injectors with fuel in the system. It is possible to build up a large amount of fuel in the intake, which could cause a severe backfire to occur when starting the engine, possibly damaging intake components. It is recommended to turn the fuel supply manual valve OFF and run the engine until it switches back to gasoline operation before performing this operation.

### **3.2.3 Injector sequencing**

As each injector is disabled, the disabled injector will revert to gasoline. This step helps isolate a noisy or faulty injector.

If an injector is noisy, it doesn't automatically signify that it is defective, unless the noise is abnormal or is accompanied by an operational problem.

The slide bar should be moved from the "#3" position to "#10" position. Each injector fires the number of times shown on the slide bar during transition from gasoline to autogas. When a longer delay is activated, it allows for additional time when isolating injectors. Since the injector actuates once for every two crankshaft revolutions, it may take up to 20 crankshaft revolutions for each injector to actuate.

Running the engine and pressing the F5 key on the laptop or clicking on the FOIL selector will automatically sequence the injectors. The engine will automatically sequence each injector, from gasoline to autogas, or from autogas to gasoline, one injector at a time until all injectors have turned on or off.

When the screen is exited, the slide bar will revert to the programmed amount in the Sequent controller (3 cycles). The slide bar shown on the diagnostic screen is software driven by the laptop.

### **3.2.4 Replacing an injector**

The injectors are individually replaceable.

Run the engine on autogas while the manual valve on the tank is closed. When the engine reaches the minimum pressure allowed (approximately 750mbar), the engine will automatically switch over to gasoline. Allow the engine to cool down where it can be safely worked on without risk of serious burn injury.

## Tools needed

- 8mm (5/16") nut driver
- 8mm combination wrench
- 10mm nut driver or equal size socket with ratchet and extension
- 10mm open end combination wrench
- O-ring lubricant, automatic transmission fluid, or SAE 30 motor oil (drops of each) to lubricate the injector O-rings.

Disconnect the negative battery cable to prevent any accidental electrical contact.

Portions of the intake manifold inlet air ducting will have to be removed to gain access to the injector blocks. Follow standard auto-shop safety practices when removing the inlet air ducts.

The front injectors may be accessed without removing the intake plenum, but the rear injectors require the intake plenum to be removed. (Ford 5.4L shown; other models may differ in layout.)

The injectors are usually numbered by the installer, but the technician should trace the hose routing to verify which injector is connected to which cylinder.



Figure 31. Ford 5.4L front injectors

Disconnect the injector electrical connector, then the hose fastening nut on the outlet of the injector discharge hose with the 10mm combination wrench. It may be necessary to use a backup wrench on the injector retaining nut.

Loosen the injector retaining nut approximately three turns. The injector MAY dislodge itself due to internal rail pressure (less than 10 psig). When the rail pressure is discharged, the injector retaining nut may be fully removed.

Capture the curved locking washer for reuse with the new injector.



Figure 32. Ford 5.4L rear injectors

## IMPCO/BRC Sequent Plug and Drive Multi-Port Vapor Fuel Injection

Each injector is identified by a colored decal indicating the flow rate. The replacement injector **MUST** have the identical color decal (blue, orange, yellow), regardless of the serial or model number.

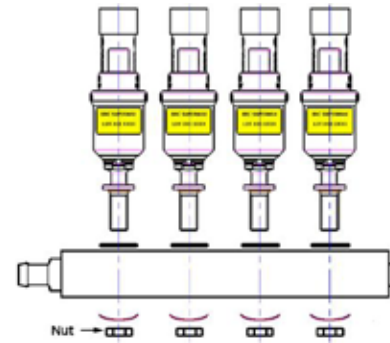

Figure 33. Injector flow-rate decal

IMPCO has released two additional injector models, one of which is interchangeable with the injector shown above. The other requires a new injector fuel rail.

L to R: Current injector; replacement “hybrid” injector with new internals and current body; new injector (2 views).

The new injector is retained by an E-Clip. The flow rate and electrical resistance values are unchanged.



Figure 34. IMPCO injector models

Carefully clean the injector rail opening with a lint-free cloth to ensure no dirt or debris enters the injector. Apply a light coating of O-ring lubricant, automatic transmission fluid or SAE 30 motor oil to the new injector O-rings and reassemble the injector into the injector rail. Insert the cupped washer (cup towards the rail as shown above) and the injector retaining nut. Torque to 62 in-lb (about 5 ft-lb or screwdriver torque).

Reinstall the injector discharge hose and torque the injector nut to 62 in-lb (about 5 ft-lb). Reinsert the injector electrical connector.

- Reassemble any removed inlet air plenum or other ducting.
- Verify that the MAP sensor was not dislodged and none of the vacuum hoses were disconnected.
- Verify that the mass air flow meter was reconnected.
- Reconnect the negative battery terminal.
- Open the tank manual service valve.

Start engine and verify injector operation.  
 On the main screen, click on the “ECU Version” button.

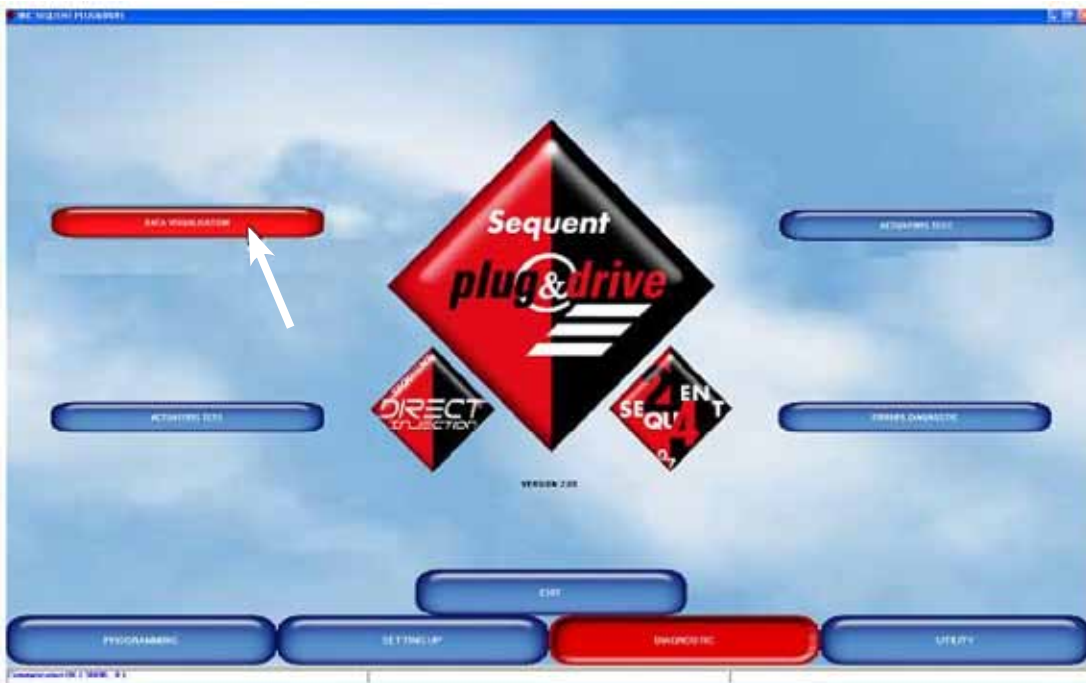

Figure 35. ECU Version button

This screen will show:

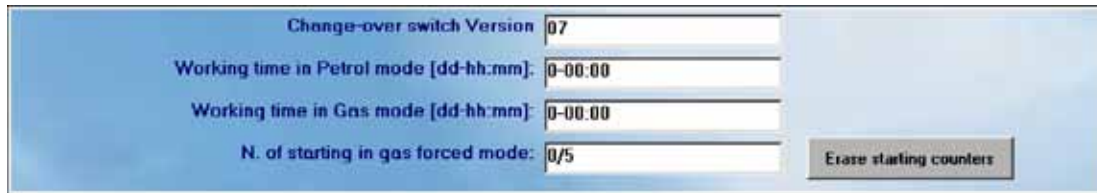

Figure 36. ECU data display

## IMPCO/BRC Sequent Plug and Drive Multi-Port Vapor Fuel Injection

The primary items of importance are:

- **First Programming Date:** This is the date the ECU was first programmed and will not change for the life of the unit.
- **Reprogramming Date:** This is the date the ECU was last programmed. If the ECU is updated, this is where the date will be shown. It may also be used to determine the approximate date the vehicle was placed in service (depending on the length of time the ECU was in parts inventory).



The screenshot shows a diagnostic tool interface with a light blue background. It contains four data fields, each with a label and a value in a white box:

- Change-over switch Version: 07
- Working time in Petrol mode [dd-hh:mm]: 0-00:00
- Working time in Gas mode [dd-hh:mm]: 0-00:00
- N. of starting in gas forced mode: 0/5

There is a button labeled "Erase starting counters" located to the right of the "N. of starting in gas forced mode" field.

Figure 37. Operational data, including number of Forced Mode starting cycles

- **Working Time in Petrol Mode:** This is the total time the system has operated on gasoline in days, hours and minutes. It does not reset with an ECU program reflash.
- **Working Time in Gas Mode:** Total time system has operated on autogas in days, hours and minutes. It does not reset with an ECU program reflash.
- **Number of Starting Cycles in Gas Forced Mode:** This number will always be 0-5 and can be reset with the Erase Starting Counters button. There is no other way to reset the number of forced starting cycles. If the driver has exceeded the number of forced cycles, the vehicle will not start if it is out of gasoline.

### 3.2.5 Maintenance

Maintenance consists of:

- Periodic visual inspection of all vacuum lines and fittings.
- Periodic visual inspection of all fuel lines and fittings.
- Periodic check of entire intake system for vacuum leaks.
- Periodic check of the condition of all wiring.
- Periodic fuel filter replacements at 15,000 mile intervals.
- “Delta-P” fuel pressure inspection / adjustment. Perform this procedure every 7,500 miles or any time the vehicle is in for a reported system condition (check engine light).
- Except for the “Delta-P” pressure check, all other maintenance items are in the IMPCO Owner’s Guide Supplement. Consult the guide for maintenance schedules.

- Always document all maintenance services (date, mileage) and the Delta P value on the vehicle service repair order. It might be helpful to document the STFT and the LTFT as well.

### 3.2.6 Setting the vaporizer outlet pressure

The vaporizer is a mechanical device and is subject to wear. Wear in either the primary or secondary pressure reduction stage may affect the outlet pressure.

To test and adjust the outlet pressure, go to the Data Monitoring screen and select the “Delta-P” for graphing (single graph, no other variables). Make sure the value is averaging around 1500 mbar at idle and at operating temperature.

“Delta-P” means the difference in pressure between the intake manifold vacuum and the fuel delivery pressure.

Make the adjustment as shown below with the engine running on autogas and the engine at full operating temperature, at least 10 minutes at idle or after a 10-minute drive.

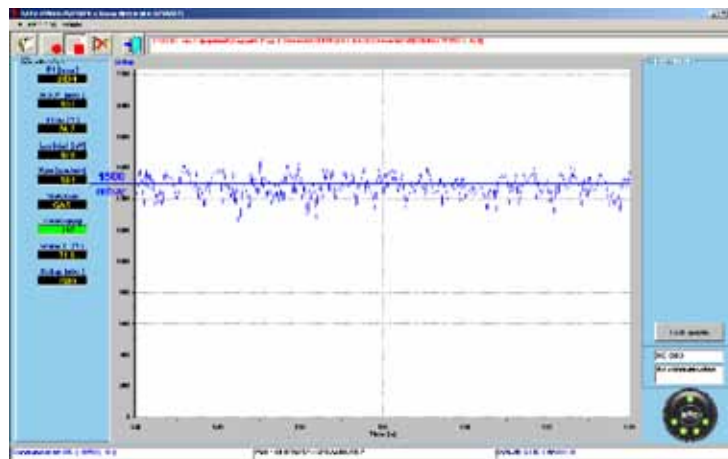

Figure 38. Delta-P adjustment

Locate the vaporizer and the adjusting screw (4mm). Slowly turn the screw clockwise to lower the pressure and counterclockwise to increase the pressure. The target is 1500 mbar (22 psig) +/- 25 mbar.

**Note:** The pressure will change under load and different temperatures.

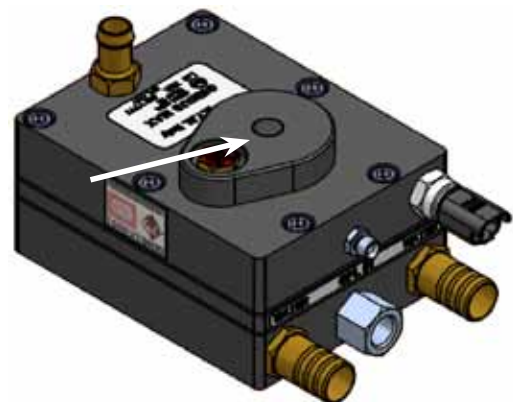

Figure 39. Vaporizer adjusting screw



## *IMPCO/BRC Sequent Plug and Drive Multi-Port Vapor Fuel Injection*

On the 2008 and 2009 Ford F-150, the vaporizer is located below the OEM PCM and behind the wiring harness connectors. Access to the adjusting screw is behind the middle harness bundle.

Different make or model vehicles may have different vaporizer locations. The vaporizer location is specified by the fuel system manufacturer and must comply with the EPA certificate of conformity.



Figure 40. 2008-09 F-150 vaporizer location

This 2010 F-150 shows the vaporizer rotated 90° and placed in front of the vehicle PCM.



Figure 41. 2010 F-150 vaporizer location

### 3.2.7 Stored P1649 trouble code

*Technician's Comment: "I have a P1649 DTC stored in the Sequent fuel system PCM. What is it and what does it do?"*

DTC P1649 is a Communication Error on the CAN-BUS data-connection link.

This code will set if an OBD-II diagnostic test is performed on the OEM PCM at the same time the Sequent fuel system is operating. The CAN-BUS can only read one computer at a time. If an OBD-II scan tool is plugged in while operating on autogas, the communication cable that was installed during the conversion and connects to the OEM ALDL will be trying to access two computers simultaneously.

#### Recommended Solution

Behind the ALDL connection is a small two-wire "twisted pair" cable with a white tag. Unplug that wire from the vehicle wire harness during any OBD-II scan. The vehicle will only operate on gasoline with that wire unplugged. This wire should be unplugged anytime the vehicle has to be tested for any OBD-II codes while operating on gasoline. It may be helpful to unplug this wire if the vehicle has to go to the dealership for any warranty repair, since it might interfere with the dealership technician's diagnostic procedure.

### 3.2.8 Vapor purge or gas cap DTC

*Technician's Comment: "I have an emission-related DTC that identifies a fuel tank that is unable to complete the vapor purge or that the gas cap is loose. How is this related to autogas and how do I service the DTC?"*

The autogas fuel system does not interface with the gasoline fuel tank purge process either mechanically or electronically. Any problems with the evaporative emission systems should be directed to the vehicle's gasoline fuel system, which is intact.

A common problem on Ford applications is the capless gasoline fuel tank. Dust or dirt on the top of the fuel door may migrate to the seal of the fuel inlet door seat, causing a vacuum leak into the tank. The door that covers the fuel filler inlet has a rubberized seal that is relatively easy to damage with a gasoline nozzle. If the seal is damaged, the fuel tank purge process cannot be completed. This can occur on any vehicle, not only vehicles that have been converted to autogas.



Figure 42. Capless gasoline fuel tank

## IMPCO/BRC Sequent Plug and Drive Multi-Port Vapor Fuel Injection

On some vehicles, an evaporative emission fault will occur when operating on autogas. An OBD-II self-test requirement is a continual fuel tank vacuum test.

All vehicles are required to check for evaporative emission system leaks, and most require the level of fuel in the tank to be within specified limits during the leak test. This requires testing of the gasoline fuel tank sending unit to ensure it is performing correctly.

The sending unit test is usually done while driving the vehicle over a predetermined distance. If the sending unit's signal does not change over this distance, then it is considered to be stuck and will set a fault code DTC. To counteract this, the Fuel Gauge Sending Unit Simulator Module was developed to allow the OEM fuel gauge to be driven by either fuel. The gauge may take some time to indicate the correct level due to buffering of the signal.

The fuel gauge transducer replicates the gasoline fuel tank value when the vehicle is running on autogas. The fuel pump transducer replicates the gasoline fuel pump. Some vehicles have a variable fuel pump speed that controls fuel pump pressure. This transducer prevents the PCM from receiving an incorrect signal. In these applications, the gasoline fuel pump is electrically disabled.



**Figure 43. Fuel gauge transducer**

The fuel gauge transducer replicates the gasoline fuel tank value when the vehicle is running on autogas.



**Figure 44. Fuel pump transducer**

The fuel pump transducer replicates the gasoline fuel pump. Some vehicles have a variable fuel pump speed that controls fuel pump pressure. This transducer prevents the PCM from receiving an incorrect signal. In these applications, the gasoline fuel pump is electrically disabled.

## Review of Chapter 3 - IMPCO/BRC Sequent Plug and Drive

Directions: Select from the list below the response which most correctly completes each of the following statements. Write the letter of your choice in the space provided.

- |                   |                          |
|-------------------|--------------------------|
| A. gas pressure   | I. 1500mb                |
| B. FOIL           | J. time                  |
| C. equal length   | K. orange                |
| D. OBD-II         | L. operating temperature |
| E. DTC            | M. bifuel                |
| F. 7500           | N. 15,000                |
| G. MAP            | O. coolant temperature   |
| H. canister purge | P. E-85                  |

- \_\_\_\_\_ 1. The Sequent P&D fuel system is designed to operate as a \_\_\_\_\_ system.
- \_\_\_\_\_ 2. When performing the fuel pressure test, the engine must be at \_\_\_\_\_.
- \_\_\_\_\_ 3. To allow the \_\_\_\_\_ to operate, the gasoline fuel level gauge will be used.
- \_\_\_\_\_ 4. The \_\_\_\_\_ sensor determines the engine load.
- \_\_\_\_\_ 5. To change from gasoline to propane, the \_\_\_\_\_ is depressed.
- \_\_\_\_\_ 6. When converted to operate on propane, the vehicle cannot operate on \_\_\_\_\_.
- \_\_\_\_\_ 7. The fuel pressure must be checked/adjusted every \_\_\_\_\_ miles.
- \_\_\_\_\_ 8. Since 1996, all automobiles and light duty trucks must comply with the \_\_\_\_\_ diagnostic standard.
- \_\_\_\_\_ 9. If an injector connection hose must be replaced, the new hose must be the \_\_\_\_\_ as the original hose.
- \_\_\_\_\_ 10. The standard fuel injector is identified by a/an \_\_\_\_\_ label.
- \_\_\_\_\_ 11. The fuel filters must be replaced every \_\_\_\_\_ miles.
- \_\_\_\_\_ 12. Before the Sequent P&D switches from gasoline to propane, which three
- \_\_\_\_\_ 13. conditions must be in agreement? <sup>12</sup> \_\_\_\_\_, <sup>13</sup> \_\_\_\_\_, and <sup>14</sup> \_\_\_\_\_
- \_\_\_\_\_ 14.
- \_\_\_\_\_ 15. To aid in diagnostics, the original vehicle's PCM is used to read the \_\_\_\_\_.
- \_\_\_\_\_ 16. The desired fuel pressure reading is \_\_\_\_\_.

*Answers: 1-M, 2-L, 3-H, 4-G, 5-B, 6-P, 7-F, 8-D, 9-C, 10-K, 11-N, 12-J, 13-O, 14-A, 15-E, 16-I*



**LIQUID PROPANE INJECTION  
ENGINE SYSTEMS:**



# ***Chapter Four***

## ***CleanFUEL USA LPI Liquid Propane Injection Fuel System***



## CHAPTER 4: CLEANFUEL USA LPI LIQUID PROPANE INJECTION FUEL SYSTEM

The CleanFUEL USA Liquid Propane Injection (LPI) fuel system is a dedicated, autogas-only system. All gasoline fuel system components are removed and replaced with propane autogas components.

### 4.1 System Overview

A Liquid Propane Injection system will always keep propane in liquid form by keeping it above its saturation pressure. See Figure 8 on p. 11.

When liquid autogas is fed to the engine it absorbs radiant engine heat, which increases its tendency to vaporize. Fuel injectors cannot meter partially vaporized autogas, and the engine will not operate with a multiphase fuel.

To keep propane autogas fully liquefied, it must be kept pressurized. The fuel is pressurized to approximately 50-65 psig above saturation pressure, which is enough to condense any partially vaporized autogas and keep it in liquid form. The partially vaporized autogas is returned back to the tank, where it is re-saturated with the tank contents. Over time, the fuel tank will gradually warm from the returned fuel, and the absorbed heat will increase the pressure inside the tank.

To achieve the boosted pressure, a submersible fuel pump is located inside the fuel tank. The operation of this pump is controlled by a separate fuel-pump control module, which also controls the tank-filling process.

#### 4.1.1 Fuel lines

The LPI system uses three different fuel lines:

- Green, for fuel supply, from the multivalve to the injectors;
- Black, for the fuel return from the pressure regulator to the multivalve; and
- Blue, for the fill connector.



Figure 45. LPI fuel-line colors

These fuel lines are fabricated from composite materials and are tested to exceed the burst pressure requirements of NFPA 58. Do not replace these lines with other fuel lines unless specifically authorized by the manufacturer. If a fuel line is damaged, replace the complete fuel line unless specifically authorized by the manufacturer. Splicing or repairing the fuel lines is not recommended.

### **4.1.2 Electronic engine control**

The LPI system uses the engine's original gasoline electronic control processor (PCM or Powertrain Control Module). The fuel mapping calibration has been optimized to obtain the best emissions and fuel economy while operating on autogas. This calibration is certified for emissions compliance and may not be altered or tampered with. The same on-board diagnostics apply as with the original gasoline calibration. The only additional step in diagnostics is the procedure for verifying fuel pressure.

An FCU (Fuel Control Unit) is used to time the “wait to start” purging process required before starting the engine. The original gasoline fuel pump control strategy remains in place; however, the FCU intercepts the fuel pump run signal and extends the pump run time and purge timing from 2 seconds on gasoline to 20 seconds for autogas. The extension is due to the increased amount of fuel vaporization with autogas in the injectors and fuel lines during engine-off periods.

The FCU provides a grounding signal to a “wait to start” light on the dash, normally the same lamp used for diesel “wait to start.” This light illuminates for 20 seconds and turns off. The driver then has 10 seconds to start the engine. If the engine does not start within a 2-3 second crank period, repeat the process by cycling the key to the off position. If the wait-to-start lamp flashes, the pump is not running and the ignition key must be cycled to re-initiate the purge cycle.

Some applications have intelligent purge timing that keeps the engine from cranking until the purge cycle is complete.

### **4.1.3 Diagnostic functions related to the PCM**

All autogas-relevant OBD-II diagnostic and control functions are retained. Gasoline-specific OBD-II codes have been eliminated during the reprogramming sequence (e.g., canister purge). By retaining the original OBD-II diagnostics, the technician can utilize existing OBD diagnostic strategies and tools when troubleshooting the vehicle.

## 4.2 First Approach to Diagnosis

- 1) Turn the ignition key on and verify that the wait-to-start indicator lamp functions correctly.
  - The start indicator lamp must be illuminated for 20 seconds.
  - The start indicator lamp should go out for 10 seconds.
  - The start indicator lamp should begin to flash after 30 seconds.

If the lamp does not illuminate or does not flash, inspect the fuse. If the lamp illuminates but does not flash, the Fuel Control Unit module may have failed.

- 2) Use a scan tool to verify any diagnostic trouble codes. Record any DTCs stored. A DTC will point to the area of a problem; however, remember many things can cause a DTC. Always refer to the original gasoline engine manufacturer's diagnosis for a DTC.
- 3) If the problem is associated with engine performance:
  - Connect the scan tool and identify DTC.
  - Connect fuel pressure gauge and verify that fuel pressure is within specification.
  - Review the data display or operating data on the scan tool.
  - Document the fuel trim data, especially short term/long term/bank 1 and bank 2.
  - Review misfire data. If a misfire is detected, inspect spark plug wires and spark plugs.
  - Always replace spark plugs with proper heat range plugs. Refer to the vehicle manufacturer's recommendation for spark plugs. Do not substitute other spark plugs, and do not change the spark plug gap unless specifically authorized by either the manufacturer or CleanFUEL USA Technical Services.

Verify driver's comments received by replicating the conditions.



### 4.2.1 Hard starting

*Driver Comment: “The engine cranks and cranks but doesn’t start.”*

**This is a frequent comment from new drivers.**

The first step is to verify that the driver has observed the automated start-and-purge sequence. The key must be recycled to the off position between each start sequence.

Some school buses have starter lockout provisions if safety doors or emergency exits are not secure. All vehicle-related lockout provisions must be resolved before attempting to diagnose autogas-related issues.

**Note:** This diagnosis covers only the autogas-modified components. If the engine does not “crank over” (i.e., the starter cannot be heard engaging the engine), diagnostics must go in that direction. The LPI system does not interface with the starter.

### Diagnostics

Assuming the driver has properly followed the automated start-and-purge process, the first diagnostic step is to ensure that there is enough fuel in the tank. The tank must have at least 7 gallons of fuel to verify that the fuel pump is fully submerged. If in doubt, meter a small amount of fuel into the system.

### Retest

If the retest is not successful, proceed. Note that the diagnostic steps are similar for a hard-start and a no-start.

## 4.2.2 Slow refueling

*Driver Comment: “The tank takes too long to fill,” or “The tank won’t accept fuel right after I get back from a trip.”*

### Step 1:

Fuel from the dispenser is first routed through a fuel filter that may be located on the frame rail or in the large blue hose between the fill connection and the tank. During filling, if this filter is sweating, frosting, or cold to the touch, it is partially restricted and must be serviced immediately.

Do NOT operate the fuel system without this filter in place. Immediate fuel-pump damage may occur.

### Step 2:

As a vehicle equipped with an LPI fuel system operates, the fuel tank gradually absorbs engine heat. The increase in temperature increases the pressure inside the tank. This process is more pronounced on a vehicle that starts and stops frequently (e.g., a delivery truck) or operates at a continuous slow speed (e.g., some school buses). At slow speeds, the tank-mounted fuel pump continues to operate at full speed while the engine is not consuming the full amount of fuel. Under these conditions more fuel is being returned to the tank; in addition, the tank may also be absorbing radiant heat from road surfaces and auxiliary equipment such as air-conditioning discharge or exhaust systems. At highway speeds, relatively little fuel is returned to the tank, and the tank temperature is not as elevated.

### Diagnostics

The dispenser pump must dispense fuel at least 50-75 psig above the tank saturated pressure. This is called “Delta P,” “ $\Delta$ -P” or “Differential Pressure.” Most dispenser stations are being retrofitted for pumps in the 125 psig “ $\Delta$ -P” range for faster filling.

### Tools Needed

- Fuel pressure gauge (CleanFUEL USA sourced)
- Fuel pressure gauge (standard pressure gauge capable of reading at least 350 psig)

### How to test the tank pressure

- 1) Access the engine compartment and the fuel pressure regulator.
- 2) Ensure the manual shutoff valve on the regulator is CLOSED, fully clockwise. Do not use tools to close the manual valve. Doing so will damage the valve seat.
- 3) Use a 16mm box-end wrench to remove the test port cap at the pressure regulator.
- 4) Install the special test gauge and hose assembly (available from CleanFUEL USA). Slowly open the test port manual shutoff valve.
- 5) With the engine off for less than 10 minutes (i.e., not a cold tank), the test pressure measured should be what is observed inside the tank. This “tank pressure” reading will be higher than the cold tank saturated pressure. A vehicle must have just returned from at least 2 hours’ driving to allow the tank to reach heat saturation pressure.
- 6) Connect the other pressure gauge to the refueling coupling at the filling connector. Assistance from your autogas vendor may be required, as a gauge adapter must be fabricated to test this pressure.
- 7) Turn on the dispenser pump for no more than five seconds. Record this reading.
- 8) Compare this reading with the pressure recorded at the engine pressure regulator test port.
- 9) If the dispenser discharge pressure is less than the warm tank pressure PLUS 50 psig (75-125 psig preferred), the dispenser should be upgraded, or the vehicle should be refueled at night or before daily operation.

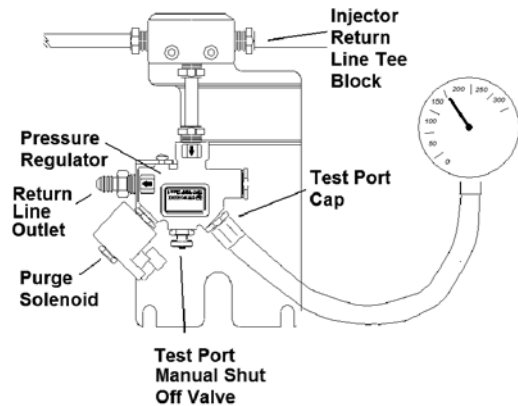

Figure 46. Tank pressure-test setup

## 4.2.3 Poor performance

*Driver Comment: “The vehicle starts with difficulty, performs poorly, or the malfunction indicator light indicates a diagnostic trouble code is stored in the vehicle’s PCM.”*

Never assume that a dashboard malfunction indicator light means there is a autogas fuel-system fault, even though the diagnostics are integrated. An MIL may be triggered by a number of vehicle faults, including in some cases, improper tire size (which might trigger an ABS fault), low tire pressure, overheated catalyst, inoperable cooling fan, loose gas cap, defect in the canister purge sequence, engine misfire, and over-rev or over-speed.

### Tools Needed

- OBD-II Scan tool

The first step to isolate the problem is to connect the OBD-II scan tool and observe the diagnostic codes.

### First Digit – System

The first character identifies the system related to the trouble code:

- P = Power train
- B = Body
- C = Chassis
- U = Undefined

### Second Digit – Code Type

The second digit identifies whether the code is a generic code (same on all OBD-II equipped vehicles), or a manufacturer-specific code:

- 0 = Generic (this is the digit zero, not the letter “O”)
- 1 = Enhanced (manufacturer-specific)

### Third Digit – Subsystem

The third digit denotes the sub-system.

- 1 = Emission management (fuel or air)
- 2 = Injector circuit (fuel or air)
- 3 = Ignition or misfire
- 4 = Emission control
- 5 = Vehicle speed and idle control
- 6 = Computer & output circuit
- 7 = Transmission
- 8 = Transmission
- 9 = SAE reserved
- 0 = SAE reserved

### Fourth and Fifth Digits

These digits are variable and relate to a particular problem. For example, a “P0171” code means P0171 - System Too Lean (Bank 1).

The most likely autogas-related generic OBD-II codes one might encounter are:

- P0171 System too lean (Bank 1)
- P0172 System too rich (Bank 1)
- P0173 Fuel trim malfunction (Bank 2)
- P0174 System too lean (Bank 2)
- P0175 System too rich (Bank 2)

P0171 and P0174 indicate a lean fuel mixture. This condition can be verified by increasing fuel trim values noted as a “plus sign” (+10 percent, for example). It is possible that the fuel pump is failing or losing pressure, or that the fuel filter is partially restricted.

When diagnosing a CleanFUEL USA LPI application, all gasoline base engine systems must be verified for proper operation before progressing to the LPI system.

One of the most significant testing steps is to connect an OBD-II diagnostic scanner and read the STFT and LTFT values. STFT is a “snapshot” of what is occurring at almost that exact time. LTFT is a longer review, more like a video of what had occurred. STFT with positive numbers indicate fuel is being added to account for a lean fuel mixture.

## Diagnostic Steps To Isolate a Fuel-Pressure Problem Versus an Electronic-Control Problem

### Tools Needed

- Fuel pressure gauge (CleanFUEL USA sourced)

### How to test the tank and fuel delivery pressure

- 1) Access the engine compartment and the fuel pressure regulator.
- 2) Ensure the manual service valve on the regulator is CLOSED, fully clockwise. Do not use tools to close the manual valve. Doing so will damage the valve seat.
- 3) Using a 16mm box-end wrench, remove the test port cap at the pressure regulator.
- 4) Install the special test gauge and hose assembly (available from CleanFUEL USA). Open the manual test port shutoff valve.
- 5) With the engine off and a cold tank, record the pressure. It should closely approximate the chart shown on p. 11 in Chapter 1 of this manual.
- 6) Initiate the start sequence, but do not start the engine. Record this as the “boost pressure.”
- 7) Start the engine and record the pressure. This is the operating pressure.

The operating pressure should be 65 to 70 psig ABOVE the static tank pressure. If no boost pressure is recorded during the initial sequence, or if the pressure does not reach 50 - 65 psig above static tank pressure, the fuel pump may have failed or be failing. If the pressure does not reach the operating or boost pressure, use a rubber mallet to apply a sharp impact force to the fuel tank directly below the fuel pump. This sudden jar may start the fuel pump; if it does, the pump should be replaced as soon as possible. The fuel pump has effectively failed, and it will fail again.

This pressure-recording process should be performed on a regular basis or during scheduled maintenance and documented on the vehicle service repair order.

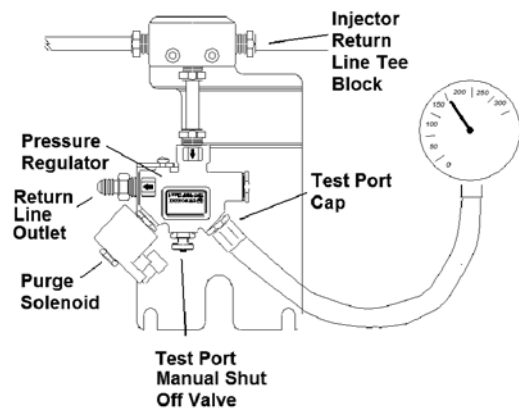

Figure 47. Tank and fuel-delivery test setup

## ***CleanFUEL USA LPI Liquid Propane Injection Fuel System***

The regulator is installed on the fuel rail return line. It maintains fuel rail pressure by controlling back pressure on the fuel lines, using a spring-loaded piston that maintains pressure at the injectors. This regulator is also equipped with an electrically operated purge solenoid that bypasses the internal piston and is actuated only during the purge cycle, which allows fuel to flow back to the tank instead of vaporizing in the lines due to heat soak when a hot engine is turned off.

#### 4.2.4 Odor complaints

*Driver Comment: "I smell propane around the engine compartment."*



#### Caution

A vehicle should never be allowed into service with a possible leak or an active odor complaint.

Perform a leak test using an approved procedure. Check for leaks at all joints and connections at the fuel tank multivalve, fill connection, and along the fuel lines. Repair any leaks before performing further tests or repairs.

When any leaks have been repaired or it has been confirmed that no leaks are present on any exposed fuel line, the next step is to check for injector leaks.

The injectors used in the CleanFUEL USA LPI system are made by either Siemens or Continental AG. The injector design is called "bottom feed," because, unlike the OEM injectors, they feed autogas along the bottom side instead of through the full injector body. Bottom-feed injectors are more tolerant of foreign debris.



Figure 48. Bottom-feed fuel injector

The LPI injectors utilize the OEM injector drivers from the OEM PCM. Depending on the original vehicle series, a short adapter wire harness may be used to adapt the injector to the OEM wiring harness. The injector coil electrically matches the resistance of most gasoline injector controllers at 12-13 $\Omega$  (ohms) or high impedance design. Flow calibrations are sized to meet the application through a small orifice called the "calibrator." The spray pattern is commonly referred to as a "pencil stream." Liquid autogas flowing out of the injector orifice immediately starts to vaporize due to the drastic pressure reduction and heat absorption.



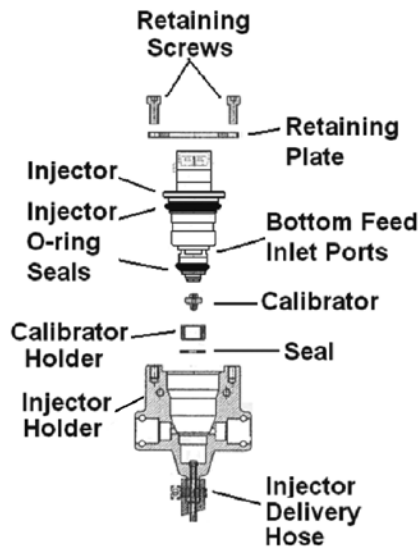

Figure 49. Injector cutaway

This cutaway of the injector stacked components and the injector body shows the flow through the center and the outlet at the bottom.

Fuel flows from the injector to the intake manifold through a small nylon tube with a rubber outer hose for thermal protection. The flexible hose allows for movement of the injector rail without damage to the injectors. The rubber hose does not carry pressure. The inner nylon tube is exposed to manifold vacuum, not vapor pressure.



Figure 50. Flexible injector hose and nozzle

The nylon tube may protrude slightly through the bottom of the brass injector nozzle.

When liquid autogas is released from pressure, it vaporizes rapidly and expands. This rapid expansion takes energy (heat), which is transferred to the fuel from whatever medium the fuel is in contact with. In this case, the autogas absorbs heat from the incoming air charge, which increases the density of the air charge, which in turn increases its mass. This additional air mass increases engine power slightly and helps reduce combustion chamber temperatures, which in turn lowers NOx emissions.

As autogas is released, it forms a small cloud of vapor whose shape does not depend on a specific shape of nozzle like a charge of liquid. Autogas exiting a simple tube opening is sufficient for proper metering.

The volume of liquid fuel delivered through this injector is 1/270th of the volume of vapor delivered through a vapor injector, since propane expands 270 times when changing from the liquid phase to the vapor phase. The internal tolerances are very precisely machined, and any foreign material that may migrate through the fuel system may cause metering problems.

### 4.2.4.1 Identifying a leaky fuel injector

A leaky injector may manifest itself as an erratic idle, negative STFT fuel trim numbers, or an under-hood odor when the engine is turned off. A leaking injector may also cause hard starting when hot or cold.

Injectors should be checked for leakage annually by performing the following steps.

## Tools needed

1. 3/8" drive ratchet wrench
2. 10mm socket with suitable extension (typically a 3- or 4-inch extension is sufficient)
3. Lubricating oil
4. Soapy water or suitable leak-check solution
5. O-ring lubricant, SAE 30 motor oil, or automatic transmission fluid

1. Remove the engine cover to access the engine compartment. You should have access to all eight injectors.

Temporary removal of the air intake ducting and wiring harness may be necessary, depending on the application.

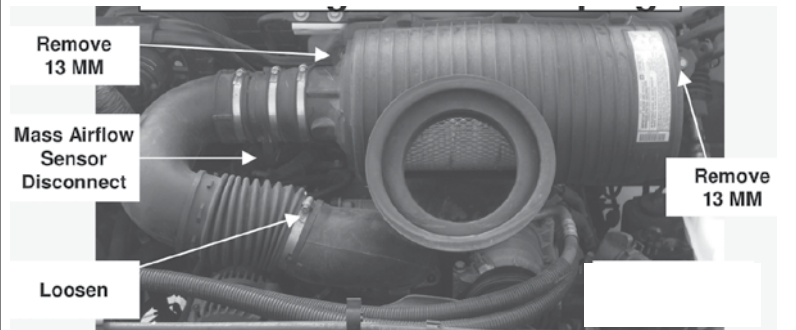

Figure 51. Removing air box and piping

2. Use compressed air to remove any dirt or debris from around the bottom of the injector nozzle.



### Warning

Eye protection is required whenever compressed air is used to blow debris, to guard against potentially serious eye injury.

3. Use a 10mm socket to carefully remove the bolt that holds the injector nozzle to the manifold. These injector retaining bolts also retain the intake manifold. Remove only one injector nozzle at a time to prevent intake manifold warping or vacuum leaks.

Apply some light penetrating oil to the injector nozzle and gently move the injector to allow the penetrating oil to lubricate the injector nozzle O-ring. The nozzle may be removed from the intake manifold.

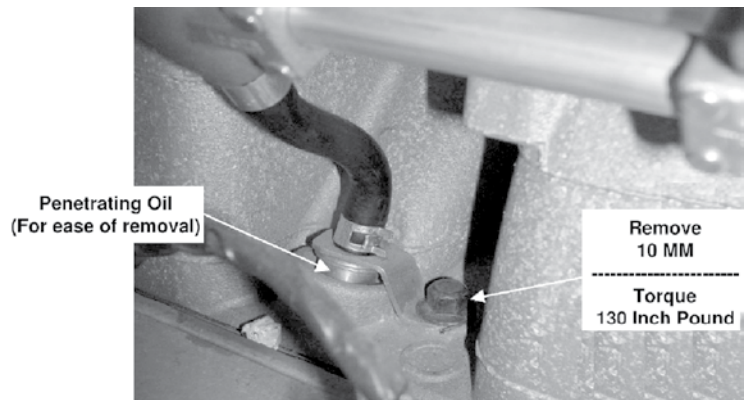

Figure 52. Removing the injector nozzle

## CleanFUEL USA LPI Liquid Propane Injection Fuel System

- Place the injector nozzle on the intake manifold where the tip of the injector nozzle is clearly visible.
- Apply a soapy solution to the tip of the injector nozzle.
- Initialize the purge sequence by turning the ignition key to the on position. Do not allow the engine to start.
- Observe the tip of the injector nozzle for any formation of bubbles or discharging autogas.
- Compare the injector nozzle tip with the following photographs:

**Note:** The amount of leakage may be not exactly match these photos. Any leakage outside of the very small amount that might be expected when a valve is closed should be considered unacceptable. One qualifying condition is that the size of the bubbles may continue to increase during the test. If the bubbles are stationary and do not increase in size, do not replace the injector.



Figure 53. Injector nozzle leak test

4. When the leak test on any single injector nozzle is complete, apply O-ring lubricant, SAE 30 motor oil, or automatic transmission fluid to the injector nozzle O-ring and reinstall. Reinstall the retaining bolt and re-torque to OEM specifications, 130 inch-pounds (10.5 ft-lb).
5. If the injector nozzle shows unacceptable leakage, mark the top of the injector body with an “X” using a permanent marker.
6. Repeat this process with each injector. Each injector with an “X” on the top should be replaced.

#### 4.2.4.2 Injector removal procedure

To remove the injectors safely, the fuel system needs to be depressurized. Follow these steps exactly to prevent potentially serious personal injury or damage to the injectors.

**Note:** Ensure that the ignition key is removed from the ignition switch to prevent accidental operation and potentially serious personal injury.

#### Tools needed

- 3mm Allen wrench
- 16mm box end wrench
- Lubricating oil

#### Safety equipment needed

- Eye protection
- Rubber gloves

## CleanFUEL USA LPI Liquid Propane Injection Fuel System

1. At the fuel pressure regulator, close the manual service valve. Locate the regulator behind or on top of the engine and the shutoff knob located on bottom of regulator assembly. Turn the knob clockwise to close.

Do not use tools to close this valve. Damage to the valve seat may occur.



Figure 54. Fuel pressure regulator shutoff knob

2. Remove the 16mm test port plug as shown below when measuring the system operating pressure. Verify that the vehicle is in a well-ventilated area and away from all ignition sources, including shop lights, electric tools and fans, two-way radios and additional personnel.

3. Using a 16mm wrench, remove the port plug located just to the right of the shutoff knob.

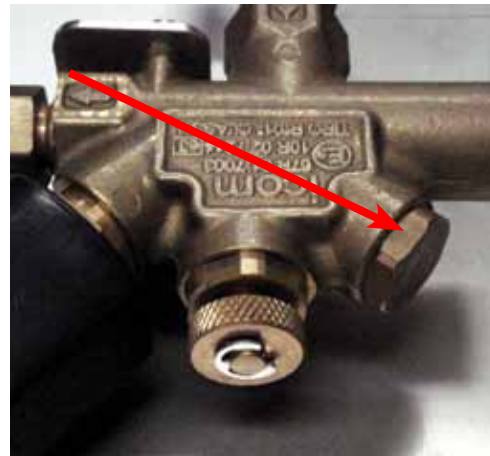

Figure 55. Regulator port plug

4. Very carefully, slowly open the manual service valve at the pressure regulator. Liquid autogas will be released from the test port opening. Eye protection and rubber gloves should be worn when releasing autogas from any device.

When the fuel stops flowing, leave the test port open to prevent any accidental buildup of pressure in the fuel rails. If there is any remaining pressure in the injector rail, the injector may be expelled when the two retaining screws are removed.

5. Locate each injector with an "X" on the top.

6. Use a 3mm Allen wrench to remove the two small screws on the injector retaining bracket.

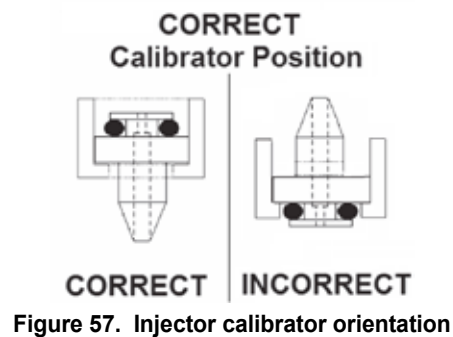

Figure 56. Injector retaining bracket screws

If the injector does not easily slip out of the brass injector body, apply a small amount of penetrant spray to the injector. Rotate the injector carefully while applying upwards pressure. A small blade screwdriver may be used to assist in removal.

7. Verify that the small brass injector calibrator did not come out with the injector. The engine will not operate properly if the injector is replaced without the calibrator in its proper location or orientation.

If the calibrator came out with the injector, carefully reinstall into the injector housing as shown in the image at right.



8. Apply O-ring lubricant, SAE 30 motor oil, or automatic transmission fluid to the two O-rings in the replacement injector and reinstall in the brass injector housing.

The injector electrical plug should be oriented in the same direction as the injector that was removed, but the injector may be rotated as needed for access.



Figure 58. Replacement injector installation

9. Tighten the two 3mm Allen screws to 26 inch-pounds torque (screwdriver torque).

10. Repeat the process for any remaining injectors.

11. When completed, reinstall the 16mm cap on the pressure regulator test port and tighten. Close the manual valve on the regulator. Do not use any tools to tighten the manual valve. Damage to the valve seat may occur.
12. Cycle the ignition switch through two complete purge cycles to remove any air from the system and to refill the fuel lines with liquid autogas.

Perform one last leak check of any opened fittings and the injector housings; then test-drive the vehicle.

If DTCs were recorded, verify proper STFT trim values and clear the DTC as specified.

The manufacturer may require that the injectors be returned for examination or warranty.

### 4.2.4.3 Fuel tank components



#### **Warning**

Service to any of these components requires a full tank evacuation to atmospheric pressure. Failure to do so may result in serious personal injury or death.

All internal components are accessed through the multivalve. These components are:

- Fuel pump with integrated fuel filter
- Fuel level sending unit
- Optical sensor for detecting over-fill conditions
- Hydrostatic pressure relief valve
- Pressure switches
- Fuel tank fill solenoid and pressure sensor

#### **Tools needed**

- 5mm Allen wrench
- 15mm open-end wrench
- 17mm open-end wrench
- 22mm open-end wrench
- Adjustable-jaw wrench
- 5/16" standard flat-blade screwdriver
- #2 Phillips screwdriver
- 3/8" drive ratchet wrench with a short extension
- 16mm deep-well six-point socket



Figure 59. Outside view of tank multivalve



Figure 60. Internal tank view of fuel-pump housing



Figure 61. Internal tank view of fuel-level photocell



Figure 62. Internal tank view showing the fuel-level gauge floats, photocell, and fuel-pump housing

#### 4.2.4.4 Tank evacuation

Move the vehicle to a suitable location with adequate ventilation, preferably outdoors. There should be sufficient access to an open area to evacuate the tank and possibly flare off autogas vapor. Any ignition source within 25 feet should be eliminated.

**Note:** Before proceeding to empty the tank, remove the fuse from the LPI main harness fuse holder on the passenger side of the engine compartment just above the splash shield.

#### Multivalve description

Early multivalves had a pressure relief valve integrated into the multivalve. This multivalve was easily identified by the 1" aluminum or brass tube protruding through the aluminum cover plate. Later multivalves had two wing nuts holding the multivalve down. The pressure relief valve was repositioned to the tank body and the opening in the multivalve was plugged.





**Figure 63. Early-style multivalve with integrated pressure-relief valve**

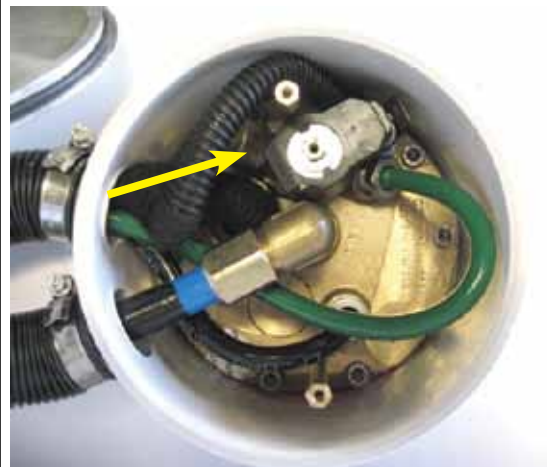

**Figure 64. Later style multivalve without integrated pressure-relief valve**

#### **4.2.4.5 Fuel pump removal**

1. Locate the tank multivalve cover and remove. Close the manual supply valve located adjacent to the black solenoid and the green supply line. Turn the knurled knob clockwise with fingers to close.

**NOTE:** This valve must remain open during normal operation.



**Figure 65. Manual supply valve**

2. Locate the regulator behind or on top of the engine and the shutoff knob located on the bottom of the regulator assembly. Turn the knob clockwise to close.



**Figure 66. Regulator shutoff knob**

3. Using a 16mm wrench, remove the port plug located just to the right of the shutoff knob.



Figure 67. Regulator port plug

4. The fuel lines may now be depressurized. Keep hands clear of the discharge port on right side of regulator. Open the knob on regulator slowly to release autogas liquid and vapor.

**NOTE:** The fuel will be released to the atmosphere. A hose may be connected to the discharge port opening to direct any released fuel to a safe location.

5. Once pressure is released from the fuel line, close the knob on the regulator and reinstall the port plug.

6. Return to tank and remove the black lock-off solenoid by removing the small e-clip and washer. Then, using a 16mm or 5/8" deep well socket, loosen and remove solenoid post at its base. Take out steel plunger and spring from post and reinstall the post. Tighten firmly.

**NOTE:** When the manual valve is opened, fuel will flow from the hose fitting since the solenoid has been disassembled.

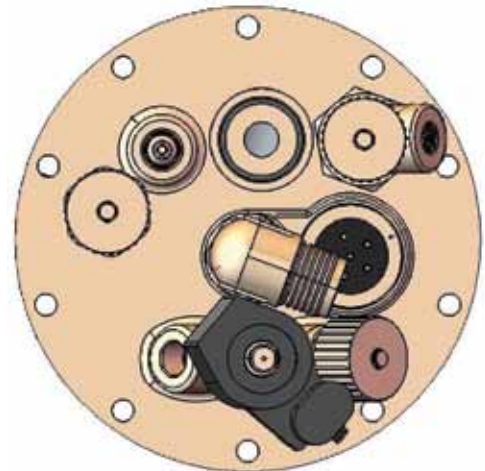

Figure 68. Solenoid and shutoff valve

## CleanFUEL USA LPI Liquid Propane Injection Fuel System

7. Use a 17mm wrench to loosen and remove fitting for green supply hose where it is threaded into the multivalve.



Figure 69. Supply hose fitting

8. Install evacuation hose fitting into multivalve port. Tighten fitting.

9. Install a suitable fitting on the other end of the evacuation hose to connect to the vapor return on the recovery or receiving tank. This fitting will vary depending on which receiving tank is used.

If the fuel pump is operable, proceed to step 10.

If the fuel pump is not operable, slowly open the manual valve on the sending tank. Autogas will transfer if the vapor pressure in the sending tank is greater than that in the receiving tank. When the pressure equalizes between the tanks, fuel will stop flowing. Fuel remaining in the sending tank must then be vented to the atmosphere.

Proceed to step 13.

**Note:** The receiving tank should be at least 50 percent larger than the sending tank, to allow for thermal expansion without encroaching into the 20 percent reserve space.

10. Use a short jumper wire and strip a half-inch off each end; this will be your jumper wire for the fuel pump. Install the appropriate male spade fittings on the jumper wire.

11. Access the engine compartment or locate the fuse-box located on the passenger side of engine compartment right above the engine computer. **Note:** This location may vary, depending on vehicle application.

12. Remove fuse box lid. Locate and remove the gray fuel pump relay in rear driver's side of fuse box.

To electrically activate the fuel pump, remove the relay and find pin numbers 30 and 87 listed on the underside of the relay. Install the jumper wire; the pump should energize. At the tank, the fuel pump operation may be audible. On some applications where a defective fuel pump is suspected, a sharp blow from a rubber mallet directly on the underside of the fuel tank near the fuel pump may start up the fuel pump.

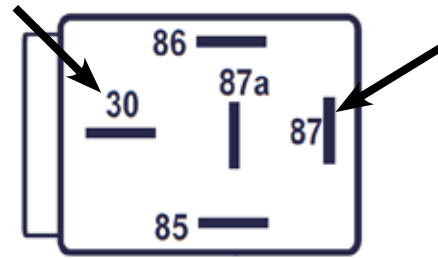

Figure 70. Fuel pump relay

13. Return to tank and open the supply valve (the one that was previously closed). At the receiving tank, open the inlet valve where the evacuation line was connected. Pumping should commence. The fuel line may vibrate with the flow of fuel. Note that fuel is being transferred by occasionally checking the mechanical gauge on tank.



Figure 71. Fuel supply valve

**Note:** Do not let the fuel pump run empty, and do not “deadhead” the pump pressure for more than 30 seconds.

14. Remove the 1/2” blue fill hose fitting, at the 90° fitting in the center of the multivalve using a 22mm wrench. Loosen the hose’s fitting nut where it threads onto the elbow. Support the brass elbow with a suitable wrench so it does not break off while loosening or tightening the hose nut.

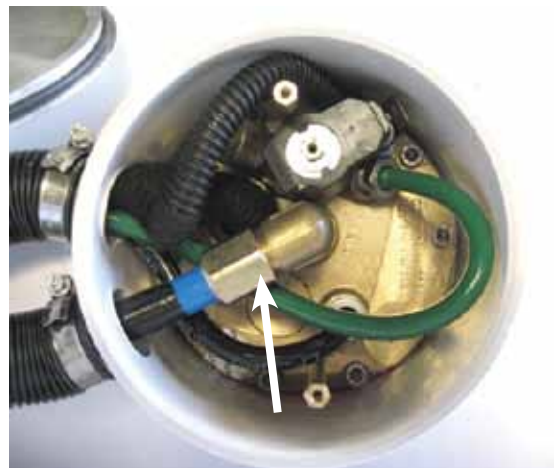

Figure 72. Fill hose fitting nut

Loosen the clamp holding the black convoluted pipe to the neck on the tank and pull both black pipe and blue hose out of the tank collar. If the multivalve is equipped with an integrated pressure relief valve, the aluminum tube may be unscrewed from the multivalve.

15. When all fuel has been transferred from the fuel tank, remove the jumper wire and replace the pump relay and fuse box lid.

16. Close the receiving tank valve. Then close the supply valve on the motor fuel tank. Remove any other transfer hose connections as required. Use caution when disconnecting the fuel lines, as they will be pressurized.

17. All remaining pressure in the LPI tank will be released as vapor. The vapor may be connected to a vertical flare stack or safely released until all vapor pressure is vented. Verify by opening the vapor valve located on the multivalve.

18. Once you have started to release liquid/vapor and can monitor evacuation progress, loosen and remove the black return line fitting from the multivalve. Loosen the hose clamp from black convoluted pipe that has fuel lines inside and pull pipe loose from collar. Carefully push the fuel lines and fittings through the collar, leaving only the electrical harness in the collar. Remove the electrical connector plug by squeezing the two ears on either side of plug and pulling out the plug using a slight rocking motion. Once removed, spread the wires out flat so the multivalve can clear them when removed.



Figure 73. Return line fitting

19. Carefully, and in a cross-pattern, loosen and remove the 5mm Allen screws holding down the multivalve. Some residual pressure may remain from the evacuation process, so remove these screws slowly. Very carefully, push on the fill elbow fitting to separate the O-ring seal. The multivalve should come loose.

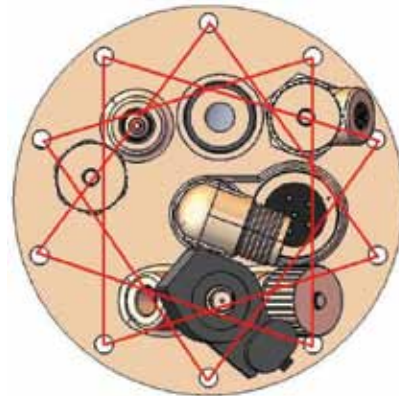

Figure 74. Multivalve retention screws



### Warning

Any dirt or debris in the flange opening may be blown free when the multivalve is removed due to remaining tank pressure. Eye protection is mandatory to guard against potentially serious eye injury.

20. Carefully lift the multivalve off the tank flange. Angle the multivalve towards the neck opening where the wires come through, keeping the wires flat against the inside of the neck until multivalve clears. The internal wires are thin and delicate and will not allow the multivalve to be pulled out more than right in front of the tank opening. Prevent excessive wire pulling by fabricating a wire hanger to support the multivalve from the tank.

21. Behind the multivalve, the small green wire connected to a pressure switch male terminal may be disconnected for additional maneuvering clearance.

The green wire is the pressure control circuit for the fuel level photocell sensor. If it is disconnected, the vehicle will sense the tank is full and it will not accept fuel.

See wiring diagram on step #31 for assistance.

22. Behind and attached to the multivalve are two aluminum pipes with 90° bends. The multivalve may need to be angled upwards to clear the tank flange.



Figure 75. Multivalve vapor pipes

23. With the multivalve out of the tank flange, the inside of the tank is accessible. Using a flashlight and/or a mirror, observe directly down to the bottom of the tank, following the thick rubber fuel line to the fuel pump housing. The housing sits in a 3-sided steel box with three springs strung across the open side. The pump module is held in place by two springs at the side and one at the top of the box that is stretched over a boss on the pump housing.



Figure 76. Fuel-pump housing

24. While supporting the multivalve in one hand, use the other arm to reach in and lift the retaining spring up and over the boss on the housing. Carefully lift the pump housing out of its box and carefully remove the housing out of the tank and let it hang outside. Avoid pulling on any of the wires.

**Note:** Two thin wires are attached to the rheostat for the dash fuel level gauge. Be very careful not to put any strain on these wires. The multivalve can hang on the tank by sliding the larger 90° vapor pipe on the multivalve into one of the holes in the neck of the tank opening.

**Note:** Be very careful not to nick the mounting surface of the O-ring.



**Figure 77. Fuel-pump housing removal**

25. Now that the multivalve is supported, remove the electrical wire clip from the top of the pump. Then loosen the fuel hose clamp and remove the rubber hose from the top of the pump. Locate the thin plastic hose that comes from the pump housing that attaches to a small brass fitting on the underside of the multivalve. Take a razor knife and slice the very end of the hose just enough to allow the hose to be released (about 1/2”).

**Note:** If this is a warranty repair, save the old pump and wiring to be returned to the manufacturer for RMA inspection.



**Figure 78. Fuel-pump electrical connection**

26. If the pump wire harness was provided with the replacement pump, install it and skip to step 31. If you have a pre-assembled pump cup assembly, skip to step 32.

27. Locate the original fuel pump wires; they will be the 3mm black and blue wires running to pump with a connector clip at the pump end. Cut approximately 4” off the ends of the wires where they attach to the pump.

28. Strip approximately 1/2" from the ends of these two wires. Crimp on the new fuel pump connector terminals and install them into the clip in correct phase with the pump connector when joined together.

**Note:** The updated pump has different wire terminal ends.



### Caution

Use proper wire crimping or approved wire attachment procedures whenever performing wire splicing repairs. Never use electrical tape inside an autogas tank.

29. Disassemble the original pump housing assembly. Save pump cup, screws, and the return line with brass fitting that needs to be removed from base of cup adaptor. Reuse these parts to rebuild the pump housing completely. (See below for the proper reassembly sequence). Reinstall brass fitting in new cup adaptor with the outlet hole facing the same direction as removed from the old cup adaptor and cut off the slit part of the return hose.

30. Before reinstalling the pump assembly, carefully inspect the inside of the tank. Clean out any silt and dirt with paper towels or shop rags. Verify that the pump hold-down springs are still in place. When the pump is reinstalled, the flat side of the housing goes against the springs. Re-position the top spring and stretch it up and over the boss on pump housing to secure.



Figure 79. Fuel-pump installation



31. If the wires are disconnected at the multivalve, this diagram should guide the technician for proper reassembly.

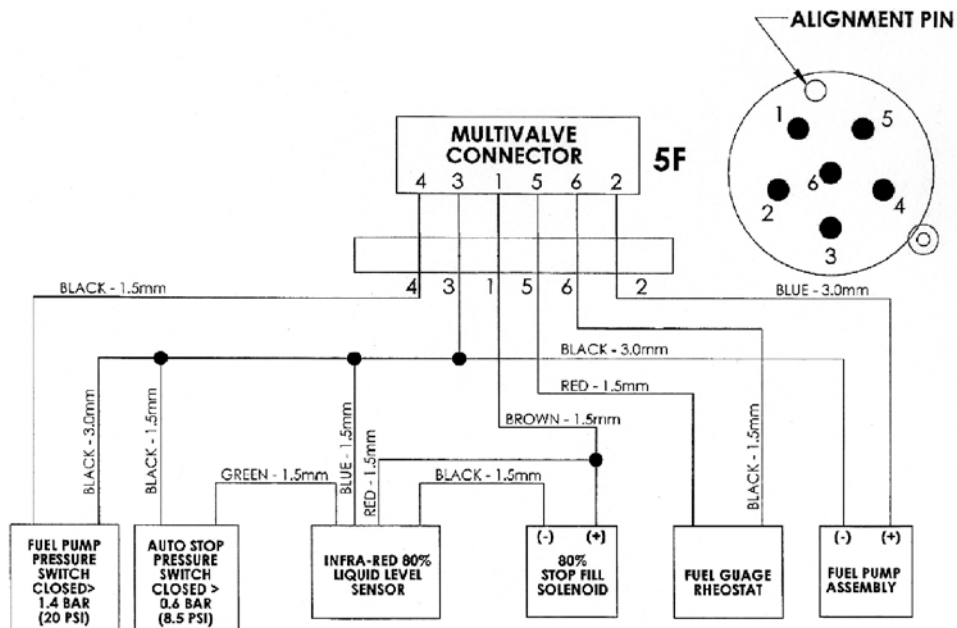

Figure 80. Multivalve wiring diagram

32. The multivalve O-ring should be replaced whenever the multivalve is removed. Install the multivalve and carefully apply a thin film of O-ring lubricant, SAE 30 motor oil, or automatic transmission fluid to the O-ring. Place the O-ring on the neck of the multivalve; it should adhere to the multivalve. Do not use any sealant. Carefully lower the multivalve into the tank neck.

**Remember:** Reinstall the green wire terminal (if removed) just before lowering multivalve into place on tank flange. Test the fill circuit using compressed air if available.

**Service Tip:** Before installing multivalve screws and hoses, use compressed air hose with a rubber tip blowgun to test the fill circuit by installing the multivalve tank harness electrical connector and reinstalling the harness fuse. Test the fuel fill circuit by forcing compressed air into the fill elbow fitting on the multivalve. Air should pass through fill elbow and multivalve into the tank. Try it twice to assure correct function. If no air will pass through, then re-inspect electrical connections on the underside of the multivalve and make sure your main harness fuse is installed and not blown. Also test the fuel pump connection by placing the ignition key to the “on” position. Then the wait-to-start light will light up and the pump should turn on. Do not run the pump dry for more than a couple of seconds.

33. The multivalve hold-down screws are to be tightened in a cross pattern using anti-seize on the screw threads. Anti-seize may be applied sparingly to the threads of hose fittings.

**Note:** Verify that the connectors and wire crimps are secure prior to reassembly. Tighten or repair as necessary. The terminals should press on firmly and require some effort to remove.

**Note:** Follow the tightening process outlined in the removal procedure shown in Step 19.

Tighten 5mm Allen head screws to approximately 75 inch-lb. torque.

## CleanFUEL USA LPI Liquid Propane Injection Fuel System

|   |   |
|---|---|
| <p>34. Reinstall all hoses and electrical plugs; reinstall solenoid lock-off spring, plunger and solenoid. Close all manual valves in multivalve and reinstall fuse back into the LPI harness. Add 7 to 10 gallons of autogas to the tank and test the multivalve with an approved leak check procedure.</p>  | <p><b>Note:</b> The fuel pump must be fully submerged in fuel to operate properly.</p>  |
| <p>35. The system must now be purged prior to operating the engine. Turn ignition key to on position to start the automated 20-second purge cycle. The pump should be audible. At the tank, slowly open the supply valve to feed the green supply line. The fuel pump sound should change as you open the valve. When the automated purge process is completed, turn the ignition key off and leak-check all reconnected hose fittings.</p> | <p>The purge process circulates liquid autogas throughout the fuel lines, including the fuel rails, injectors, and the pressure regulator. Any air that may have been introduced into the fuel system will be sent to the fuel tank where it will be removed during the next purge process (see below).</p> |

When the system has been confirmed to be leak-free, the tank is then purged. When the purging process has been completed, start the vehicle and test drive. Fill the tank and return the vehicle to service.

### Service Tip: Purge Tank

Whenever the tank is opened for service, all air must be purged from the tank. Purging is accomplished by opening the purge valve knob located at the multivalve. Air/vapor will be released under knob. The exact location may vary depending on the application, but it is typically located directly opposite the manual service valve/electrical solenoid.

Approximately five minutes' purge time is sufficient.



### Warning

For the personal safety of you and others in the area, there can be no open flame or other ignition sources within 25 feet of a purging operation.

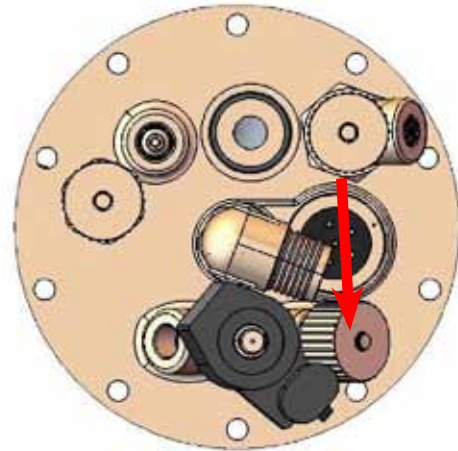

Figure 81. Purge valve knob

## 4.3 Electrical System Interface

The CleanFUEL USA electrical system interface requires only four wiring connections to the original vehicle wiring, plus one new wire connection to the dashboard.

1. A dedicated 12 volt positive (fused)
  2. A dedicated 12 volt negative
  3. A dedicated Key On 12 volt source
  4. The fuel gauge interface
  5. The dash “wait light” connection
- The wiring for the injectors is a direct unplug/plug-in requiring no wiring modifications.
  - The wiring for the fuel tank multivalve is a dedicated wiring harness that is routed alongside the fuel lines.

## CleanFUEL USA LPI Liquid Propane Injection Fuel System

- The location of the FCU (Fuel Control Unit) varies, depending on the vehicle application.

Additional vehicle- or manufacturer-specific wiring intercepts may be required.

### Maintenance

- The fuel filter should be replaced at 60,000 miles.
- An annual inspection should include a full review of the vehicle's hoses, wiring, and tank mounting for routing, abrasion, or any other deterioration which might lead to failure.
- A full leak inspection should be performed any time an odor complaint is recorded. Use only an approved leak-check procedure or liquid solution.
- The annual inspection should be documented on the vehicle service repair order. The documentation should include the date and mileage, along with the STFT and LTFT values.

CleanFUEL USA fuel-pump module stack, showing the proper reassembly orientation.

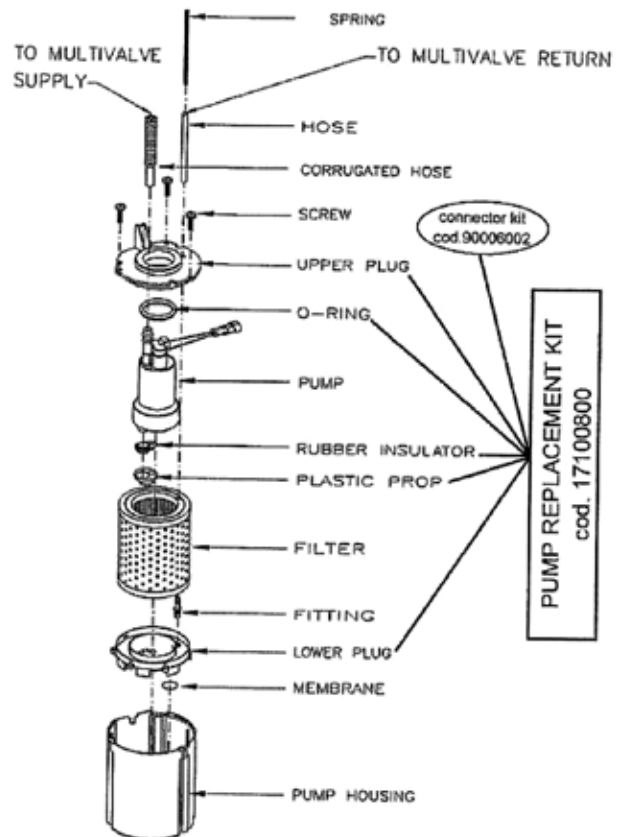

Figure 82. Fuel-pump module stack

## Review of Chapter 4 - CleanFUEL USA Liquid Propane Injection

Directions: Select from the list below the response which most correctly completes each of the following statements. Write the letter of your choice in the space provided.

- |                 |                |
|-----------------|----------------|
| A. purge        | I. boost       |
| B. gasoline     | J. static      |
| C. reprogrammed | K. bottom feed |
| D. OBD-II       | L. multivalve  |
| E. DTC          | M. dedicated   |
| F. PCM          | N. saturation  |
| G. operating    | O. 60,000      |
| H. FCU          | P. 25          |

- \_\_\_\_\_ 1. The CleanFUEL USA fuel system is designed to operate as a \_\_\_\_\_ system.
- \_\_\_\_\_ 2. The pressure at which propane remains in the liquid phase at a given temperature is called the \_\_\_\_\_ pressure.
- \_\_\_\_\_ 3. Unauthorized persons are not allowed within \_\_\_\_\_ feet during tank venting.
- \_\_\_\_\_ 4. The original \_\_\_\_\_ controls the propane fuel system.
- \_\_\_\_\_ 5. Before the engine can start, the \_\_\_\_\_ cycle automatically activates.
- \_\_\_\_\_ 6. When converted to operate on liquid propane injection, a vehicle can no longer operate on \_\_\_\_\_.
- \_\_\_\_\_ 7. The original power train control module has been \_\_\_\_\_ to operate the propane fuel system.
- \_\_\_\_\_ 8. Since 1996, all automobiles and light duty trucks must comply with which diagnostic standard?
- \_\_\_\_\_ 9. The \_\_\_\_\_ controls the fuel purging and fuel filling functions.
- \_\_\_\_\_ 10. The standard fuel injector is described as a \_\_\_\_\_ injector.
- \_\_\_\_\_ 11. The fuel filter(s) must be replaced every \_\_\_\_\_ miles.

## CleanFUEL USA LPI Liquid Propane Injection Fuel System

- \_\_\_\_\_12. Fuel pressure that is measured with the engine off is called the \_\_\_\_\_ pressure.
- \_\_\_\_\_13. Fuel pressure measured with the key on but the engine not running is called the \_\_\_\_\_ pressure.
- \_\_\_\_\_14. Fuel pressure measured with the engine running is called the \_\_\_\_\_ pressure.
- \_\_\_\_\_15. To perform diagnostics, the original vehicle's PCM is used to read the \_\_\_\_\_.
- \_\_\_\_\_16. The \_\_\_\_\_ is mounted to the tank and contains the fuel solenoid and manual service valve.

Answers: 1-M, 2-N, 3-P, 4-F, 5-A, 6-B, 7-C, 8-D, 9-H, 10-K, 11-O, 12-J, 13-L, 14-G, 15-E, 16-L





**ROUSH**<sup>®</sup>  
CLEANTECH



# ***Chapter Five***

## ***Roush LPI Liquid Propane Fuel Injection***



## CHAPTER 5: ROUSH LPI LIQUID PROPANE FUEL INJECTION

### 5.1 System Overview

The LPI fuel system used in Roush E- and F-series vehicles is similar to the CleanFUEL USA system with a few exceptions.

- The fuel rails are extruded aluminum with fiber-reinforced injected plastic injector nozzles that fit into the intake manifold.
- The fuel lines are high pressure stainless steel type 316 with flexible joints instead of flexible composite fuel lines.
- The stainless steel fuel lines are attached to the multivalve with Jiffy Tite fittings.
- Fuel pressure is maintained by an open-close solenoid with a fixed orifice located on the frame rail near the location of the original gasoline fuel filter.
- The fuel tank and fuel pump are optimized for the vehicle application using primarily Ford-sourced components, including fuel pump and filter.
- The gasoline fuel rail pressure and temperature sensor (IPTS) connector is re-pinned by converting one end of the short adapter wiring harness as provided during the conversion. The IPTS circuit has been repurposed to the LPI pressure transducer.
- The air filter cover is replaced with a new filter housing that incorporates a hydrocarbon trap.

The starting sequence is unique to the Roush LPI fuel system. Some of the original Ford E- and F-series trucks (through 2009) have no delay when starting the vehicle on gasoline. The start sequence is routed through the PCM for security and park-neutral interlock, and to prevent starting when the engine is already running.

The Roush LPI system reprograms the OEM PCM for a “soft-start.” No additional control modules are installed. When the driver turns the key to the start position and releases the key, the PCM initializes the fuel pump purge sequence. When the fuel rail pressure transducer detects the proper fuel rail pressure, the PCM commands an automated starter engagement. The driver cannot start the engine before the PCM detects sufficient fuel pressure.

Some 2007-2010 Ford products (other than the E and F series) incorporate the soft start feature even on gasoline. This feature is retained if converted to autogas.

All diagnostic features are OBD-II compliant using standard and enhanced OBD-II diagnostic equipment. Most diagnostic procedures replicate the original gasoline diagnostic flow charts.

To help evaluate fuel-system operation, the fuel rail is equipped with a conventional pressure test port Schrader valve that is used to test fuel pressure and to bleed off fuel pressure during service.

### 5.1.1 Hard starting

*Driver Comment: “The vehicle starts hard and runs rough. It idles erratically and an MIL on the dash lights up.”*

**The technician should verify the starting sequence before attempting any operational diagnostics.**

If the starter engages immediately with no delay when the driver inserts the key and attempts to start the vehicle, then no further testing is required. The PCM has been reprogrammed back to OEM programming. All Roush PCM programming includes the “soft start” sequence. The absence of this soft start sequence means the PCM program has been over-ridden by the OEM program, usually during a vehicle recall or factory TSB advisory, where the technician did not observe the Roush warning labels. This label should be clearly posted near the PCM under the hood.



Figure 83. Roush PCM warning label

OEM programming eliminates the soft start, the fuel rail purge sequence and the IPTS circuits and re-engages the canister purge and fuel tank pressure-sensing features. The stored MIL will probably state that one of these sensors is out of range.

The PCM must be removed and sent to Roush for reprogramming. The vehicle identification number (VIN) must be included with the PCM along with any recorded DTCs. There are numerous warnings indicating that the PCM has been reprogrammed, and the technician should contact Roush Technical Services prior to any PCM updates.

## 5.1.2 Slow refueling

*Driver Comment: “The vehicle takes too long to fill,” or “The vehicle will not accept fuel after I return from a trip.”*

### **Step 1:**

Fuel from the dispenser is first routed through a fuel filter. The filter may be located on the frame rail or in the large blue hose between the fill connection and the tank. During filling, if this filter is sweating, frosting, or cold to the touch, it is partially restricted and must be serviced immediately.

Do NOT operate the fuel system without this filter in place. Immediate fuel-pump damage may occur.

### **Step 2:**

As a vehicle equipped with an LPI fuel system operates, the fuel tank gradually absorbs engine heat. The increase in temperature increases the pressure inside the tank. This process is more pronounced on a vehicle that starts and stops frequently, such as a delivery truck, or a vehicle that operates at a continuous slow speed, such as some school buses. At slow speeds, the tank-mounted fuel pump continues to operate at full speed while the engine is not consuming the full amount of fuel. More fuel is being returned to the tank, and the tank may also be absorbing radiant heat from road surfaces and auxiliary equipment (air conditioning discharge or exhaust systems). At highway speeds, relatively little fuel is returned to the tank, and the tank temperature is not as elevated.

### **Diagnostics**

The dispenser pump must dispense fuel at least 50-75 psig above the tank saturated pressure. This is called “Delta P,” “ $\Delta$ -P” or “Differential Pressure.” Most dispenser stations are being retrofitted for pumps in the 125 psig “ $\Delta$ -P” range for faster filling.

### How to test the tank pressure

1. Access the engine compartment and the fuel-rail-mounted Schrader valve.
2. Install the appropriate test gauge and hose assembly.
3. With the engine off for less than 10 minutes (i.e., not a cold tank), the test pressure measured should be what is observed inside the tank. This tank pressure reading will be higher than the cold tank saturated pressure. A vehicle must have just returned from at least two hours' driving to allow the tank to reach heat saturation pressure.
4. Compare this reading with the discharge pressure recorded at the dispenser. A gauge adapter must be fabricated to test this pressure. Assistance from your propane vendor may be required.
5. If the dispenser discharge pressure is less than 50 psig higher than the warm tank pressure (75-125 psig higher is preferred), the dispenser should be upgraded, or the vehicle should be refueled at night or early in the morning before daily operation.



Figure 84. Tank pressure test port

**Note:** The test gauge must be capable of reading at least 400 psig. Do not use a conventional automotive fuel injection test gauge that cannot accommodate 400 psig pressure.

## 5.1.3 Poor performance

*“The vehicle starts hard and performance is poor,” or “The malfunction indicator light indicates that a diagnostic trouble code is stored in the vehicle’s PCM.”*

Never assume that a dashboard malfunction indicator light means the fault is in the autogas fuel system, even though the diagnostics are integrated. An MIL may be triggered by a number of vehicle faults, including in some cases improper tire size (which might trigger an ABS fault), low tire pressure, overheated catalyst, inoperable cooling fan, loose gas cap, defect in the canister purge sequence, engine misfire, and over-rev or over-speed.

The first step to isolate the problem is to connect the OBD-II scan tool and observe the diagnostic codes.

The most likely generic OBD-II codes one might encounter that could be related to autogas operation are:

- P0171 system too lean (bank 1)
- P0172 system too rich (bank 1)
- P0173 fuel trim malfunction (bank 2)
- P0174 system too lean (bank 2)
- P0175 system too rich (bank 2)

Diagnostic codes P0171 and P0174 indicate a lean fuel mixture. This condition can also be verified by increasing fuel trim values noted as a “plus sign” (e.g., +10 percent). It is possible that the fuel pump is failing or losing pressure, or that the fuel filter is partially restricted.

Diagnostic codes P0172 and P0175 indicate a rich fuel mixture. This condition can also be verified by decreasing fuel trim values, noted as a “negative sign” (e.g., -10 percent). It is possible that a fuel injector has ingested some debris and is not closing fully. These codes will be more common on vehicles operating at low-speed conditions. At higher engine speeds, an injector that is not fully closing will more closely match a normal injector flow rate.

### 5.1.3.1 Isolating a defective fuel injector

The vehicle’s PCM will usually set an MIL and register a stored DTC indicating an individual cylinder misfire. Connect an OBD-II scan tool and record any stored DTCs.

DTC codes will be displayed with the following information:

- The letter “P,” meaning power train
- The number “0” (zero), meaning generic. The number “1” would indicate a manufacturer-specific DTC which would change the diagnostic flow chart.
- The third number in the sequence indicates a specific target DTC:
  - 1 = Emission management (fuel or air)
  - 2 = Injector circuit (fuel or air)
  - 3 = Ignition or misfire
  - 4 = Emission control
  - 5 = Vehicle speed and idle control
  - 6 = Computer and output circuit
  - 7 = Transmission

Ignition or misfire codes are followed by the cylinder number. The cylinder numbers are as the OEM has the cylinders listed, not the number in the firing order:

- P0301 cylinder 1 misfire detected
- P0302 cylinder 2 misfire detected
- P0303 cylinder 3 misfire detected
- P0304 cylinder 4 misfire detected
- P0305 cylinder 5 misfire detected
- P0306 cylinder 6 misfire detected
- P0307 cylinder 7 misfire detected
- P0308 cylinder 8 misfire detected

Most OEM OBD-II scan tools have an individual cylinder balance test function that may be used to confirm a specific cylinder fault.

### 5.1.3.2 Replacing an injector

After a failed injector is identified, it must be replaced. The Roush CleanTech fuel injector is a bottom-feed injector that is fitted into a dedicated extruded aluminum fuel rail and located close to the position of the original gasoline injectors.

The fuel pressure at the engine must be reduced.

## Tools needed

- Pressure gauge with bleed attachment
- 3mm Allen wrench
- O-ring lubricant, SAE 30 motor oil, or automatic transmission fluid (drops of each)

1. Close the manual service valve at the fuel tank. The manual valve is located next to the electrical solenoid.



Figure 85. Manual service valve

2. Connect the appropriate pressure test gauge to the Schrader valve located on the driver's side fuel rail. Use the fuel pressure gauge bleed fitting to drain the fuel from the fuel rail.



### Warning

This process drains all fuel lines and both fuel rails. Exiting liquid autogas will be cold and may cause frostbite if exposed to skin. To guard against serious personal injury, eye and hand protection should be used at all times.



Figure 86. Tank pressure test port



## Roush LPI Liquid Propane Fuel Injection

3. Loosen, then remove the two 3mm Allen head machine screws from the injector retaining bracket and pry the injector out of the fuel rail. A light spray of lubricating oil around the injector may aid in removal.

**Note:** Some early production Roush LPI systems used an internal snap-ring instead of the Allen head screws.



### Warning

To guard against potentially serious personal injury, remove the two screws slowly. Liquid autogas may be trapped in the fuel rail. The injector may be expelled if the two screws are removed before all of the fuel is bled from the system.

4. Apply O-ring lubricant, SAE 30 motor oil, or automatic transmission fluid to the two O-rings in the replacement injector and reinstall in the fuel rail. Do not dip the injector in oil.

The injector electrical plug should be oriented in the same direction as the injector that was removed, but the injector may be rotated as needed for access.

Once the fuel rail is pressurized, the injector should not be rotated.



Figure 87. Replacement injector installation

5. Tighten the injector retaining screws to 25 inch-pounds (screwdriver torque).

6. Open the manual valve at the tank and leak-check the injector and fuel rail.

## 5.1.3.3 Testing tank and fuel delivery pressure

1. The engine must be cold (off for more than four hours).
2. Access the engine compartment and the fuel-rail-mounted Schrader valve.
3. Install the test gauge and hose assembly. The test gauge should be capable of reading 400 psig.
4. Record the pressure with the engine off and the tank cold. The reading should closely approximate that shown in the chart indicating the relation between tank pressure and temperature in Chapter 1 of this manual.
5. Operate the vehicle until it reaches engine operating temperature, or at least two hours of driving, to ensure the fuel tank is also heat-saturated. It may be helpful to test this pressure after the vehicle returns from a normal route.
6. With the engine off for less than 10 minutes but not a cold tank, the test pressure measured should be what is observed inside the tank. This “tank pressure” reading will be elevated above the cold tank saturated pressure.
7. Initiate the start sequence but do not start the engine. Record this pressure. It is called the “boost pressure.”
8. Start the engine and record the pressure. This is called the “operating pressure.”

This pressure recording process should be performed regularly or during scheduled maintenance and documented on the vehicle’s service repair order.

The operating pressure should be 65 to 70 psig ABOVE the static tank pressure. If no boost pressure is recorded during the initial sequence, or if the pressure does not reach 65 psig above static tank pressure, the fuel pump may have failed or be failing. If the pressure does not reach the operating or boost pressure, use a rubber mallet to apply a sharp impact force to the fuel tank directly below the fuel pump. This sudden jar may start the fuel pump; if it does, the pump should be replaced as soon as possible. The fuel pump has effectively failed, and it will fail again.

If the fuel pump still does not start to operate, and it is verified that there is electrical current at the pump, the fuel tank must be emptied and the fuel pump replaced.

### 5.1.3.4 Fuel tank evacuation

The tank needs to be emptied prior to any in-tank service, including the fuel pump, fuel filter, fuel tank level sending unit, or any other internal switch or sensor.

All tank venting and evacuation operations must be performed outdoors or in a well-ventilated area. No tank evacuation or defueling should be performed near in-ground service pits, basement entrances or similar low-lying areas where autogas vapor could collect. Failure to do so may result in fire or explosion, with potentially serious personal injury or death.

Verify that there are no ignition sources such as electric tools, drop lights, fans, heaters, or radios within 25 feet of the vehicle during the tank evacuation process. Failure to do so may result in fire or explosion, with potentially serious personal injury or death.

If the fuel pump is operable, connect a defueling fitting to the fuel rail Schrader valve as shown above. This fitting should connect to a hose that is capable of at least 350 psig pressure. The hose should have the capability of coupling to a receiving tank with a minimum capacity of at least 50 percent more than the sending tank volume. For example, if the sending tank has approximately 30 gallons of fuel, the receiving tank should have the internal capacity of at least 45 gallons fuel capacity (58 gallons water capacity). The extra volume allows for thermal expansion without encroaching into the 20 percent reserve space.

At the multivalve, close the manual service valve located adjacent to the electric solenoid. Do not use tools to close this valve; internal damage may result. Open the hose at the Schrader valve to allow the fuel to vent from the fuel lines and fuel rails.

Remove the E-clip on the electric solenoid and slip the solenoid off the solenoid stem. Using a 16mm (5/8") deep socket, very slowly loosen the solenoid stem. Some fuel will escape. Remove the solenoid stem, the internal plunger and spring, and reassemble the solenoid stem to the multivalve. This places the tank in full manual mode.



Figure 88. Manual service valve E-clip removal

At the Schrader valve test port on the fuel rail, disconnect the hose and with the appropriate tool, remove the Schrader valve core. Place the removed valve core in a secure location for reassembly. Reconnect the hose to the Schrader valve test port.

Connect the evacuation hose to the receiving tank and open the receiving valve (usually the manual valve fitting). Slowly open the manual valve on the sending tank. Fuel will begin to flow immediately.

Unless the sending fuel tank fuel pump is operable, the fuel tank will transfer fuel based on vapor pressure. When the pressure has equalized, the transfer will stop. The rate of transfer depends on the fuel level and the temperature of both the sending and receiving tank. Since liquid is being transferred from the sending tank into the receiving tank, approximately 80 percent of the fuel will be transferred by pressure alone. Fuel remaining in the sending tank must be vented to the atmosphere.

Reinstall the Schrader valve in the fuel rail test port.

If the fuel pump is operable, remove the 5-wire multivalve pass-through connector and apply 12 volts to pin #2 while grounding pin #3 to the tank connector pins.

Transfer all fuel to the receiving tank.

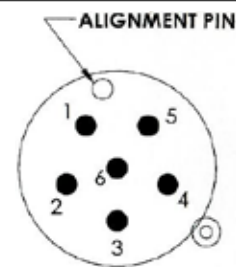

Figure 89. Multivalve pass-through connector

Carefully vent the remaining autogas to the atmosphere. When the pressure is fully depleted, the multivalve may be removed.

The technician may find it helpful to remove the tank from the vehicle for access, as the multivalve and fuel lines are in close proximity to the vehicle bed and window.



Figure 90. Multivalve location in pickup bed

### 5.1.3.5 Fuel tank removal

Shown is the 2009-2010 F-150 and F-250 in-bed mounted fuel tank. There is also an optional under-bed toroidal (donut-shaped) tank. E-150 and E-250 vans have the fuel tank mounted under the body. The removal procedures are different, but the basic operation remains the same.



### Warning

To guard against potentially serious personal injury, the fuel tank must be empty before it can be safely removed from the vehicle.

### Tools needed

- 5mm Allen wrench
- 15mm open end wrench
- 17mm open end wrench
- 22mm open end wrench
- Adjustable jaw wrench
- 5/16" standard flat blade screwdriver
- #2 Phillips screwdriver
- 3/8" drive ratchet wrench with a short extension
- 16mm deep well six point socket
- Jiffy Tite fuel line disconnect tool (typically the same tool used on 1/4" to 5/16" fuel lines)

1. Close the manual valve at the multivalve on the tank.

2. Disconnect the electrical connector at the multivalve.

3. Using a 22mm wrench, remove the 1/2" blue fill-hose fitting at the 90° fitting in the center of the multivalve. Loosen the hose's fitting nut where it threads onto the elbow. Support the brass elbow with a suitable wrench so it does not break off while loosening or tightening the hose nut.

4. Insert the Jiffy Tite release tool around the stainless steel line and depress until the retaining spring is released. Gently pull the tubing from the multivalve.

5. Remove the pressure relief valve vent hose (not shown).



Figure 91. Multivalve fuel lines, wiring and shutoff knob

**Note:** Do not scratch the stainless steel tubing.

6. Under the vehicle, disconnect and cap the two stainless steel fuel lines. Verify that the two fuel lines will lift through the bed grommet without binding or scraping. Put protective caps over the open fuel lines that remain in the vehicle to prevent debris from entering the lines.

7. Disconnect the 1" vent hose and the hose at the fuel filler filter.

8. Disconnect the 6-pin flat wire connector.

9. Locate the four tank hold-down nuts and remove.

10. Attach a suitable lifting device to the lug at the top of the tank and slowly lift tank from the vehicle.

11. The tank will separate from the support plate.

12. Disassemble the guards as required to gain access to the tubing (may not be required on all installations).

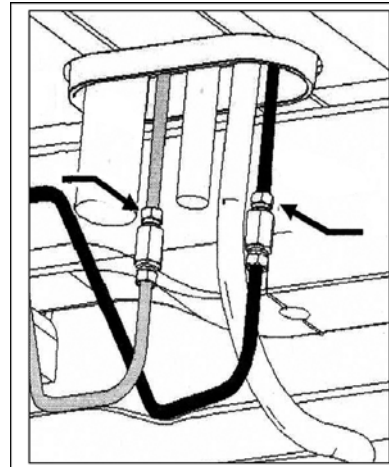

Figure 92. Under-bed fuel lines



Figure 93. Tank hold-down nuts

13. Remove the ten 5mm Allen head machine screws holding the multivalve to the tank. The tank may retain some vapor pressure. Remove the screws in stages.



### Warning

Any dirt or debris in the flange opening may be blown free when the multivalve is removed, due to remaining tank pressure. Eye protection is mandatory to guard against potentially serious personal injury.

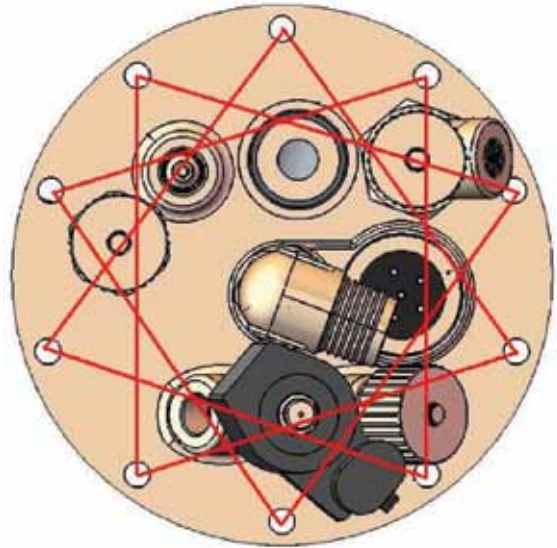

Figure 94. Multivalve retention screws

14. Carefully pry the multivalve loose and lift it from the tank. The multivalve has several wires and fuel lines attached to its back side. These may be disconnected if necessary. Label the disconnected wires and hoses if necessary. Place a protective cover on the tank; then lay the multivalve on the tank top. Be careful not to place any strain on the wires or tubes.

### Legend

1. Pressure relief valve vent tube
2. Optical sensor for the electrically activated automatic stop fill valve
3. Rheostat for the fuel level gauge sending unit
4. Fuel pump module
5. Fuel filter

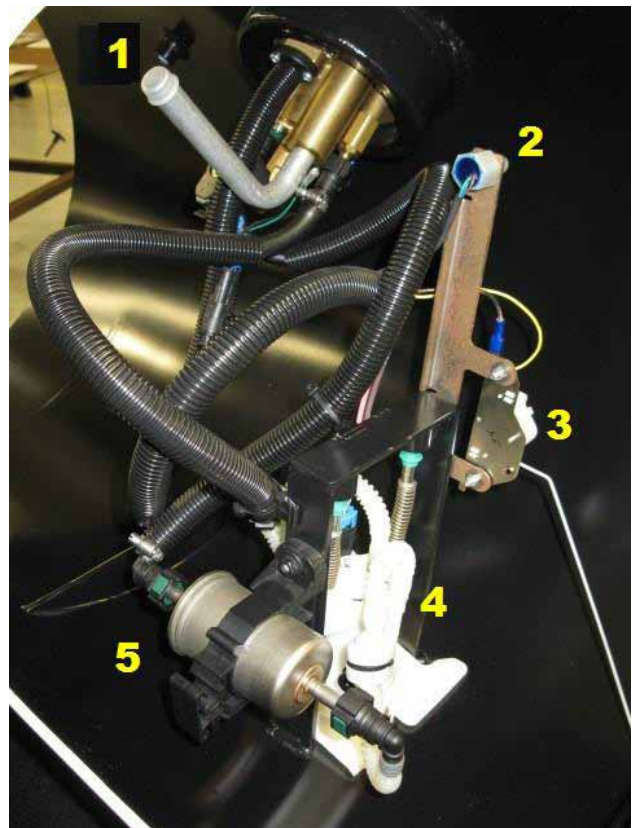

Figure 95. Roush LPI tank internal components

The fuel filter is removed by depressing the two green quick-release clips and sliding the couplings off the filter.

The fuel pump is retained inside the tank by two spring-loaded legs. Depress both of the green retaining lugs at the top of the spring legs. The pump may be lifted loose. One end of the discharge tube connects to a tee fitting that connects to a metal tube that is permanently attached to the tank. The tee fitting must be worked loose from the metal tube before withdrawing the pump and filter from the tank.

The fuel pump has an additional fuel filter that is attached to the inlet of the pump. The pump, pump housing, and inlet filter are replaced as a unit.

Perform the necessary pump and filter replacement steps and prepare for reassembly.

### 5.1.3.6 Tank reassembly

Reassembly of the fuel tank is basically the reverse of the disassembly.

The multivalve O-ring should be replaced whenever the multivalve is removed. Carefully apply a thin film of O-ring lubricant, petroleum jelly, SAE 30 motor oil, or automatic transmission oil to the O-ring. Place the O-ring on the neck of the multivalve. It should adhere to the multivalve. Do not use any sealant. Carefully lower the multivalve into the tank neck.

1. Reinstall the fuel pump and filter into the tank, reversing the procedure used during removal. Verify that the fuel filter clips are secure by gently pulling on the fuel lines at the filter inlet and outlets.
2. Verify that the two legs that retain the fuel pump module are secure in their respective sockets.
3. Ensure that the tee is connected to the metal tube installed in the tank.



Figure 96. Roush LPI tank internal components



4. The multivalve hold-down screws are to be tightened in a cross pattern, using anti-seize on the screw threads.

Tighten the 5mm Allen head screws to approximately 75 in-lb torque (6 ft-lb)

Perform the re-torque sequence twice to verify proper tightness.

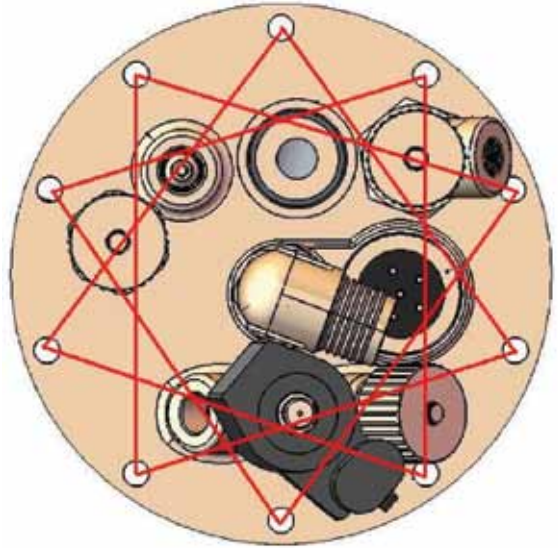

Figure 97. Retention-screw tightening sequence

5. Apply a drop of automatic transmission fluid to the tip of each stainless steel tube as it presses into the Jiffy Tite fitting and reinsert the tube into the fitting. The tube should click into place. The tube can rotate inside the fitting.

6. Reinstall the black wire connector until it clicks into place.

7. Reinstall the blue fuel line fill hose onto the large 90° fitting. A light application of anti-seize compound may be used. Do not use pipe thread sealer.

8. Verify that all removed guards and fuel lines are returned to their positions inside the tank shield.

9. Attach a suitable lifting device to tank lug and return the tank to the vehicle. Verify that the fuel lines, electrical wires, and tank vent pass through the bed access port.

10. Confirm that the tank rests on the four rubber isolator pads. Verify that the pads did not become loose during the removal process. Do not install the tank without the rubber isolator pads.



Figure 98. Tank isolator pad

11. Torque the four retaining nuts to 25 ft-lb.
12. Under the vehicle, reconnect the two fuel lines. Verify that the lines are not interchanged. A light drop of motor oil or anti-seize compound may be applied to the threads. Tighten the fittings finger tight; then use two wrenches and tighten them fully to 14 to 16 ft-lb torque. NOTE: Always use a backup wrench when tightening fittings.
13. Reconnect the tank vent hose and the fill connector at the fuel filter.
14. Reconnect the flat 6-wire electrical connector. Secure the connector to the wire harness with wire ties.
15. Put about 5 gallons of autogas into the fuel tank and leak-check the multivalve.
16. Verify that the manual valve at the multivalve is closed. Remove the solenoid stem, then replace the solenoid spring and plunger. Carefully tighten the reassembled solenoid stem to approximately 10 ft-lb torque. Reinstall the solenoid coil and e-clip. Open the manual valve fully.
17. The system must now be purged prior to operating the engine. Turn ignition key to the START position and immediately turn the key off. Under the hood, reconnect the pressure gauge to the Schrader valve test port and open the bleed valve for approximately five seconds. Repeat this process several times.
18. Perform a full system leak inspection.
19. To purge the air from the tank, place the vehicle in a well-ventilated area (no ignition sources within 25 feet) and open the 80 percent fixed maximum liquid level gauge approximately one turn. Allow the tank to vent for approximately 10 minutes. Close the 80 percent fixed maximum liquid level gauge.
20. Drive the vehicle normally to confirm proper performance. After all performance tests have been completed, refill the tank with autogas.

### 5.1.4 Engine dies or runs rough

*Driver Comment: “The vehicle starts, but quits running after a few seconds,” or, “The vehicle starts hard and runs rough for several minutes.”*

**The technician should verify the starting sequence before attempting any operational diagnostics.**

During the initial start and purge sequence, a flow control valve under the vehicle opens and allows a full circulation of autogas throughout the system. Any partially vaporized fuel will be returned to the tank where it will be re-saturated into liquid. If the flow control valve remains open, not enough pressure will be available to condense all the fuel to the liquid phase.

If the solenoid valve will not energize, the fuel system may take a considerable time to purge the partially vaporized fuel from the system.

The flow control solenoid is located where the original gasoline vehicle fuel filter was mounted.

The flow control solenoid energizes (opens) during the purge sequence and closes when de-energized. When the solenoid is de-energized, fuel circulates through a fixed orifice inside the valve, which maintains fuel-rail back pressure.



Figure 99. Flow control solenoid

#### **Symptoms of a flow control valve that does not energize or open:**

- Difficulty starting. The operator tries multiple times to get the vehicle started, especially when warm.
- Runs rough for several minutes. The vehicle starts but runs very roughly for several minutes. Afterwards performance may or may not improve.
- Dashboard MIL DTC, specifically the P0171 and P0174 which indicate a lean fuel mixture. This condition will also be verified by increasing fuel trim values noted as a “plus sign” (e.g., +10 percent).
- The lean condition exists because partially vaporized fuel is in the fuel rail. Vaporized fuel cannot be metered through the fuel injectors at the same rate as liquid fuel and will result in fuel starvation.

## Review of Chapter 5 - ROUSH Liquid Propane Injection

Directions: Select from the list below the response which most correctly completes each of the following statements. Write the letter of your choice in the space provided.

- |                        |                   |
|------------------------|-------------------|
| A. purge               | J. static         |
| B. gasoline            | K. bottom feed    |
| C. reprogrammed        | L. multivalve     |
| D. OBD-II              | M. dedicated      |
| E. DTC                 | N. saturation     |
| F. PCM                 | O. 60,000         |
| G. operating           | P. 25 feet        |
| H. reprogramming label | Q. Schrader valve |
| I. boost               |                   |

- \_\_\_\_\_ 1. The Roush fuel system is designed to operate as a \_\_\_\_\_ system.
- \_\_\_\_\_ 2. The pressure at which propane remains in the liquid phase at a given temperature is called the \_\_\_\_\_ pressure.
- \_\_\_\_\_ 3. Unauthorized persons are not allowed within \_\_\_\_\_ during tank venting.
- \_\_\_\_\_ 4. The original \_\_\_\_\_ controls the propane autogas fuel system.
- \_\_\_\_\_ 5. Before the engine can start, the \_\_\_\_\_ cycle automatically activates.
- \_\_\_\_\_ 6. When converted to operate on liquid propane injection, a vehicle can no longer operate on \_\_\_\_\_.
- \_\_\_\_\_ 7. The original power train control module has been \_\_\_\_\_ to operate the propane autogas fuel system.
- \_\_\_\_\_ 8. Since 1996 all automobiles and light duty trucks must comply with which diagnostic standard?
- \_\_\_\_\_ 9. The \_\_\_\_\_ is located near the PCM and provides a warning for technicians.
- \_\_\_\_\_ 10. The standard fuel injector is described as a \_\_\_\_\_ injector.
- \_\_\_\_\_ 11. The fuel filters must be replaced every \_\_\_\_\_ miles.

## Roush LPI Liquid Propane Fuel Injection

- \_\_\_\_\_12. Fuel pressure that is measured with the engine off is called the \_\_\_\_\_ pressure.
- \_\_\_\_\_13. Fuel pressure measured with the key on but the engine not running is called the \_\_\_\_\_ pressure.
- \_\_\_\_\_14. Fuel pressure measured with the engine running is called the \_\_\_\_\_ pressure.
- \_\_\_\_\_15. To perform diagnostics, the original vehicle's PCM is used to read the \_\_\_\_\_.
- \_\_\_\_\_16. The \_\_\_\_\_ is mounted to the tank and contains the fuel solenoid and manual service valve.
- \_\_\_\_\_17. The \_\_\_\_\_ is used to measure the running pressure.





# **Chapter Six**

## ***Prins Vapor Sequential Injection System***

## CHAPTER 6: PRINS VAPOR SEQUENTIAL INJECTION SYSTEM

The Prins Vapor Sequential Injection (VSI) system is a bifuel system (propane autogas and gasoline). All gasoline fuel-system functions are retained and remain fully operational.

The procedures that follow assume that the fuel system being diagnosed is EPA-certified. If the ECU programming is altered during any of these procedures, it must be restored to EPA-certified status before the vehicle is returned to service.

### 6.1 System Overview

Prins manufactures VSI systems and components. Installers are certified by Prins or its authorized representative. The systems are designed to operate in series with the original gasoline fuel system, which the autogas fuel system does not influence in any way. To comply with EPA certification requirements, the autogas fuel system must be fully transparent to the gasoline fuel system when operating in gasoline mode.

The Prins system begins at the high-pressure fuel lock-off at the vaporizing regulator. The system installer may install additional components that are not provided by Prins. This chapter covers Prins-supplied components only.

Items marked with an asterisk are not provided by Prins and will not be covered in this chapter.

- \*Fuel tank
- \*Fill connector
- \*High-pressure fuel lines
- Vaporizer / pressure regulator
- Fuel lockoff solenoid
- Low and high pressure fuel filters
- Low-pressure fuel lines
- Fuel injectors
- Fuel metering nozzles
- Gas temperature and pressure sensor (located in the fuel filter canister)
- Coolant temperature sensor (combined with the vaporizer regulator)
- MAP sensor
- Selector switch
- Wiring harness



### 6.1.1 Theory of operation

The VSI fuel system determines optimum air-fuel mixtures by using manifold vacuum, engine RPM and engine displacement to calculate engine load. These calculations set the “shift value” for autogas operation—i.e., the difference between the injector pulse width for autogas and the pulse width for gasoline.

The VSI system uses “speed density” calculations to determine the shift value needed to adjust for injecting propane autogas vapor instead of liquid gasoline. This adjustment occurs even when the OEM fuel system uses mass air flow (MAF) calculations. The VSI system reads the values calculated for gasoline from the OEM fuel-trim tables and adjusts the injectors’ start time and on-time to optimize for the density, volume and octane rating of autogas vapor.

More autogas may be added to the base fuel calculations if required by the vehicle’s condition.

### 6.2 Basic System Operation

The VSI system automatically defaults to gasoline in the event of major component failure that forces the fuel system out of its designed or programmed limits. These conditions include, but are not limited to:

- **Loss of electric power.** This may occur due to a loss of ground or 12V reference. The normally closed relays that control the fuel injectors are located inside the ECU. If the injector relays are not energized, they default to the gasoline mode.
- **Unplugged ECU.** If the ECU is unplugged, it will not operate on either fuel (see above). The gasoline fuel injectors are wired through the ECU.
- **Unplugged sensor.** If a sensor that was added during the conversion is electrically unplugged, the system will default to gasoline. The sensors are:
  1. Gas pressure / gas temperature sensor
  2. Vaporizer coolant temperature sensor
  3. MAP sensor (if installed; currently an optional accessory)
- **Excessive throttle opening or engine demand.** The system may default to gasoline if the engine is not at full operating temperature.
- **Fuel pressure too high or too low.** The system may default to gasoline if the vaporizer delivers autogas at a pressure outside the program limits.

The default to gasoline occurs to prevent damage to the exhaust catalytic converter.

Each of these components requires a unique diagnostic sequence. It is often helpful to begin a series of diagnostic steps starting where the fuel is stored. Each step should be completed in sequence to isolate the possible failed component.

### 6.2.1 No operation on autogas

*Driver Comment: “The vehicle won’t run on autogas.”*

The technician should always verify the fuel level in the tank before attempting to diagnose a non-operable condition.



#### Caution

If the green and red LED lamps on the selector switch are blinking, the ECU has not been programmed or has lost its programming through an electrical fault. It must be either re-programmed or returned to the original installer for updating.

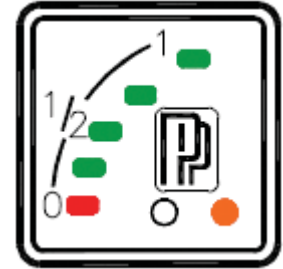

Figure 100. Fuel selector switch

#### Step 1

This step must be performed **AFTER** validating the vehicle’s operation on gasoline. Follow standard diagnostics to isolate the gasoline operation. These steps include, but are not limited to, ignition primary signal, crank position signal, injector signal, fuel pressure, battery and cranking voltage.

If the vehicle will not operate on gasoline or autogas, perform the gasoline diagnostic steps first. The “no-start on gasoline” condition **may** be accompanied by a Malfunction Indicator Lamp on the dash. Resolve any gasoline-related faults before proceeding with other diagnostics.

In many cases, a no-start or no-run condition may be simply traced back to a lack of fuel. To verify, as shown in Figure 101, carefully open the 80 percent fixed maximum liquid level gauge on the autogas tank to confirm that there is pressure available at the tank. If vapor escapes when the 80 percent fixed maximum liquid level gauge is opened, enough fuel should be present to run the engine.

A fuel-pressure sensor prevents the vehicle from running on propane if the pressure is too low for proper vehicle operation.



Figure 101. 80 percent fixed maximum liquid level gauge

The Prins fuel system requires a minimum of 750mbar (12 psig, or the pressure set in the minimum PSYS table) to operate. If fuel pressure is below that level, the vehicle will automatically revert to gasoline mode to prevent a lean air-fuel mixture from damaging the exhaust catalyst. This condition might occur if the secondary fuel flow or pressure is restricted or the fuel tank is almost empty.

If in doubt, add a small amount of autogas to the tank and retest.

**Note:** The fuel gauge on the tank indicates the approximate fuel level and should not be used during vehicle refueling or to validate the precise fuel level.

**Note:** If fuel is present in the tank but the pressure is outside the system's design limits, the system will not switch over to autogas.

### **Step 2**

The vehicle will default back to gasoline operation if the Prins ECU is deprived of electrical power or if the electrical system ground is insufficient or removed.

Verify the 7.5 amp fuse at the positive power supply wire lead (the red wire, #25-51). If the fuse is blown, place another fuse of the same rating in the fuse holder provided. If this fuse also blows, do NOT install another fuse until the source of the circuit overload is determined and corrected.

A common cause of a circuit overload is a pinched or cut wire where the auxiliary wire circuit is routed, usually near a sharp piece of metal such as a body panel or engine bracket. A defective electrical solenoid, such as a fuel lockoff, can also cause a circuit overload. Disconnect one or both of the electrical solenoids and retest the circuit.

### Installer's Tip

A short-circuit tester can help locate a shorted or grounded contact. Testers are available from most automotive supply stores at a reasonable cost.

Place the two electrical clips in the fuse holder. Then slide the meter along the wire harness. The needle will swing in the direction of the grounded circuit. Continue until the needle swings in both directions: this is the area where the circuit is grounded.

A tester may be fabricated from a universal 10-amp circuit breaker with stud mounts. Install 12 inches of 16-gauge wire to each stud with a wire ring-terminal and attach an alligator clamp to the other end of each wire. An inexpensive compass serves as the meter.



Figure 102. Short circuit tester

### Step 3

If the vehicle is a new conversion that operates normally on gasoline but not on autogas, it is possible that the ECU was not activated or reverted back to an unactivated condition.

**Note:** Diagnostic procedures from this point on require access to the Prins Diagnostic Program. Technicians who do not have the Prins Diagnostic Program should contact their fuel-system supplier for assistance.

**Note:** The following diagnostic procedures outline only the most frequent driver or technician comments or complaints. By reviewing these procedures and the accompanying guide, the diagnostic technician should be able to work through most repairs.

## 6.3 Accessing the Prins Diagnostic Program

Obtain the latest version of the Prins Diagnostic Program. This software is only available through an authorized Prins distributor and must be activated with a password e-mailed from Prins. Only one installation is allowed per diagnostic software disk. A proprietary diagnostic cable is also required and is only available through a Prins distributor.

Once the program is installed and operable and the cable plugged in, the user should verify that there is a valid USB or serial port connection and rectify any deficiency. The user should have a general familiarity with PC computers and be able to resolve any communication issues between the computer and the Prins Diagnostic Program.

Initialize the Prins Diagnostic Program by clicking on the desktop icon. The following screen should appear as shown below in Figure 103:

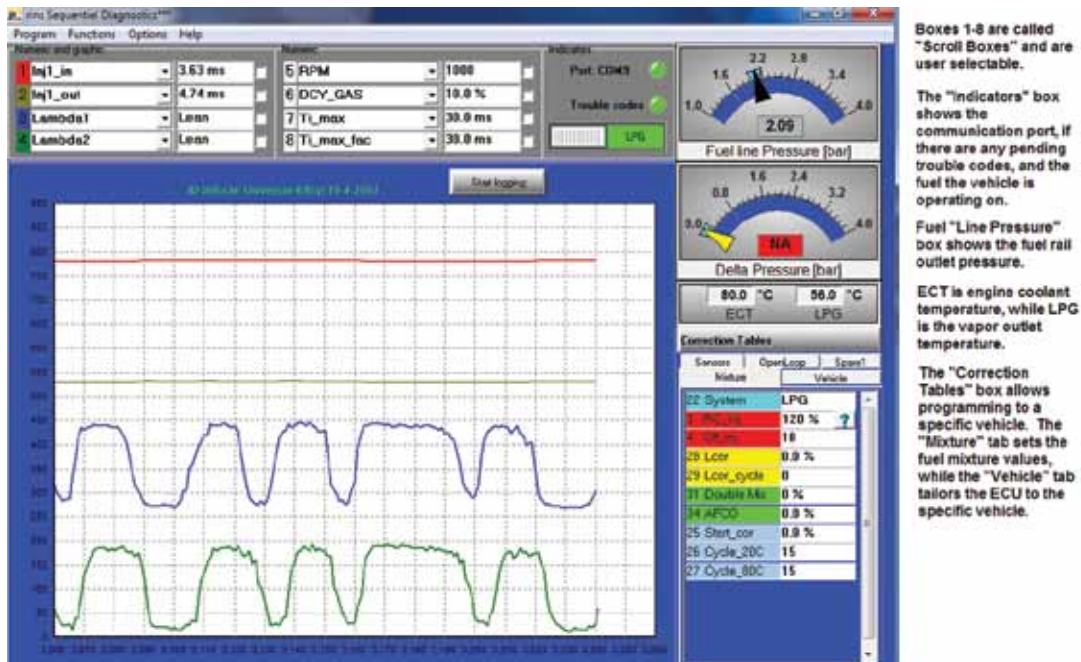

Figure 103. Diagnostic screen

The Prins Diagnostic Program is required to activate the internal program in the ECU. Press F11 on the keyboard or click on the Functions menu in Figure 104. If the ECU is not activated, the vehicle will not operate on autogas.

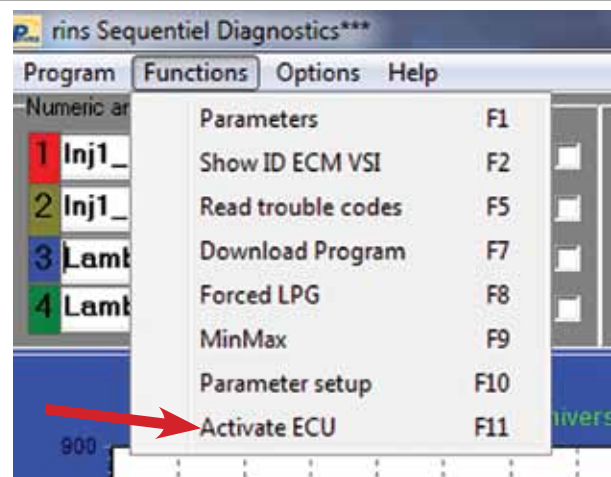

Figure 104. Activate ECU/F11

Figure 105 shows two different vehicle identifications. This display shows that the program is not vehicle-specific and is user-adjustable. If the ECU were programmed for a specific vehicle, this identification should display the programmed vehicle's name, as assigned and saved when the fuel system was initially programmed. If the fuel system is EPA- or CARB-certified, the display should (but is not required to) show the vehicle's engine family and unique identification.

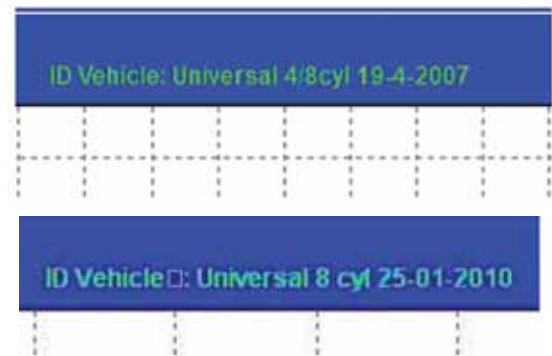
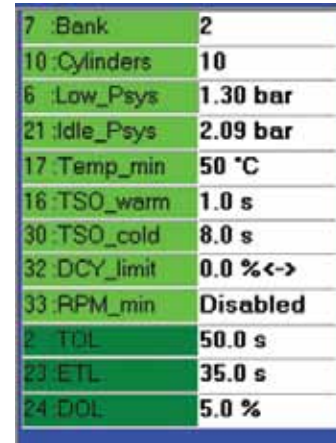

Figure 105. Vehicle description/identification

## Prins Vapor Sequential Injection System

The information in Figure 106 was entered during initial programming and verified if a difficult problem is diagnosed:

#7 describes the engine as a two-bank or V-type engine;  
#10 displays the number of cylinders;  
#6 describes the lowest pressure at which the system will operate;  
#21 describes the idle pressure;  
#17 describes the minimum switchover temperature;  
#16 describes the Time to Switch Over in seconds with the engine warm;  
#30 describes the Time to Switch Over in seconds with the engine cold;  
#32 describes the Duty Cycle on gasoline, usually set at the default value of 0.0 percent;  
#33 describes the minimum RPM limit of the engine, either enabled or disabled.



|               |          |
|---------------|----------|
| 7 :Bank       | 2        |
| 10 :Cylinders | 10       |
| 6 :Low_Psys   | 1.30 bar |
| 21 :Idle_Psys | 2.09 bar |
| 17 :Temp_min  | 50 °C    |
| 16 :TSO_warm  | 1.0 s    |
| 30 :TSO_cold  | 8.0 s    |
| 32 :DCY_limit | 0.0 %<-> |
| 33 :RPM_min   | Disabled |
| 2 :TOL        | 50.0 s   |
| 23 :ETL       | 35.0 s   |
| 24 :DOL       | 5.0 %    |

Figure 106. Initial programming screen

The information in Figure 107 was entered during initial programming and verified if a difficult problem is diagnosed:

#22 shows the fuel used;  
#3 is the injector offset, which should display a positive percentage greater than 100 percent but not more than 130 percent. The recommended initial programming is 15 percent additional injector offset compared to gasoline, or 115 percent.  
#4 is the amount of additional fuel added at low speeds, to help maintain idle mixture, displayed as time added in milliseconds.  
#28 and #29 are not changed.

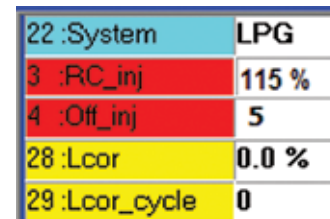

|                |       |
|----------------|-------|
| 22 :System     | LPG   |
| 3 :RC_inj      | 115 % |
| 4 :Off_inj     | 5     |
| 28 :Lcor       | 0.0 % |
| 29 :Lcor_cycle | 0     |

Figure 107. Fuel selection and injector offset

## Note

If the ECU has been locked, the diagnostic technician will see this image, in Figure 108, if a change in programming is attempted. Only the initial programmer will have access to this operation.



Figure 108. Locked calibration

### 6.3.1 Diagnostic procedures

One of the first diagnostic steps is to verify that no trouble or diagnostic codes are stored in the Prins ECU. If an emission code sets in the OBD-II PCM while operating on autogas, a corresponding code will be set in the Prins ECU. If the vehicle is operating on gasoline and a fault code is set, it will not set a code in the Prins ECU unless the fault is autogas-related or related to the installation process, e.g., a wiring malfunction.

The Indicators box shown in Figure 109 illustrates the communications port, the trouble code indicator LED, and the fuel the vehicle is operating on.



Figure 109. Diagnostic fault indicator

Clicking on the red LED as shown in Figure 110 will bring up a pop-up box that shows the fault and gives a brief description.



Figure 110. Display showing trouble code, fuel and fault description



### 6.3.2 Prins trouble code chart

| Trouble Code | Definition  | Check / solution  |
|--------------|---|---|
| 100          | The lambda signal is remaining too rich too long.                       | Verify when operating on gasoline and LPG that there is good lambda (O <sub>2</sub> sensor) signal movement.  |
| 101          | The lambda signal is remaining too lean too long.                       | Verify when operating on gasoline and LPG that there is good lambda (O <sub>2</sub> sensor) signal movement.  |
| 102          | The lambda signal is remaining too lean during open loop.               | Verify when operating on gasoline and LPG that there is good lambda (O <sub>2</sub> sensor) signal movement.  |
| 110          | T-ECT where the temperature of the ECT sensor is above 171°C            | Verify if the ECT sensor (blue) in the vaporizer is connector is connected to ground.   |
| 111          | T-ECT where the temperature of the ECT sensor is above -40°C            | Verify if the ECT sensor (blue) in the vaporizer has a power connection.  |
| 120          | T-LPG where the temperature of the system is above 171°C                | Verify the ground connection of the pressure/temperature sensor in the filter unit.   |
| 121          | T-LPG where the temperature of the filter is below -40°C                | Verify the power connection of the pressure/temperature sensor in the filter unit.  |
| 150          | PSYS (pressure) where the pressure of the system is below the set level | Based on a pressure drop in the system, this can be caused by an empty LPG tank, incorrect solenoid valve, restricted fuel filter or incorrectly adjusted pressure. |
| 160          | ECM-VSI not activated   | Activate the LPG computer with the diagnostic program, using the F11 function key.  |
| 180          | T-Board is greater than 90°C.   | LPG computer circuit board has overheated. Relocate the VSI ECU in a cooler location.   |
| 181          | Battery voltage too high  | Verify board voltage / alternator output and condition of the battery.  |

| Trouble Code                    | Definition  | Check / solution  |
|---------------------------------|---|---|
| 210-220-230-240-250-260-270-280 | (Where the second digit is the injector number and the third digit means the injector current overload).<br><br>• VSI injector overload, with the switch beeping 2 times per second.            | Injector current too high, verify for short circuiting.   |
| 211-221-231-241-251-261-271-281 | (Where the second digit is the injector number and the third digit means the injector current is at no-load).<br><br>• VSI injector no load, with the switch beeping 2 times per second.        | The injector current is too low, verify loose or poor wire connections.   |
| 310                             | Adjusted pressure on idle out of range  | Adjust the idle pressure to the value shown by parameter "Idle Level." This fault code will only be set when the coolant temperature is higher than 70°C. |
| 311                             | Fault while changing or programming the ECU   | Verify parameter settings, re-flash VSI-ECU with latest firmware. Contact Prins if update unsuccessful.   |
| 320                             | PSYS voltage too low; the LED is blinking 2 times per second.   | Verify the ground connection of the Pressure/temperature sensor in the filter unit.   |
| 321                             | PSYS voltage too high. Set with a delay of 2.5 seconds. Changes into an active fault code.<br><br>• Gasoline mode<br>• The beeper sounds at half-second intervals.<br>• Reset after 10 minutes. | Verify the power connection of the Pressure/temperature sensor in the filter unit. Also see fault 322.  |

## Prins Vapor Sequential Injection System

| Trouble Code | Definition   | Check / solution   |
|--------------|--|--|
| 322          | <p>PSYS more 3.5 Bar in gasoline mode.</p> <ul style="list-style-type: none"> <li>• The beeper sounds at half second intervals.</li> <li>• Resets after 10 minutes.</li> </ul>   | Verify the coolant temperature (T-ECT) and the vaporizer for leakage of the first stage.   |
| 330          | Unexpected parameter change  | Verify parameter settings, re-flash VSI ECU with latest firmware. Contact Prins if unsuccessful.   |
| 340          | The fault is emitted when the vaporizer's temperature continues to be lower than 55°C after 10 minutes.  | Verify the coolant connections/coolant circuit.  |
| 341          | <p>Gas leakage, system pressure is less then 1.25 Bar after 4 hours when the engine is not running.</p> <ul style="list-style-type: none"> <li>• The LED is blinking at 2 times per second.</li> <li>• This code may be triggered when the pressure has dropped by more than 0.4 bar after 15 minutes after the engine has been switched off.</li> </ul> | Verify the system for gas leakage.   |
| 360          | Battery voltage too low, less than 7.5 volts   | Verify the power supply wires of the system. Verify the condition of the battery. Battery voltage that is too low can cause faults in both gasoline and autogas operation. |

Clicking on the trouble code radio button as shown below in Figure 111 opens the fault box identifying the fault code, in this case Fault 251: injector 5, no load.

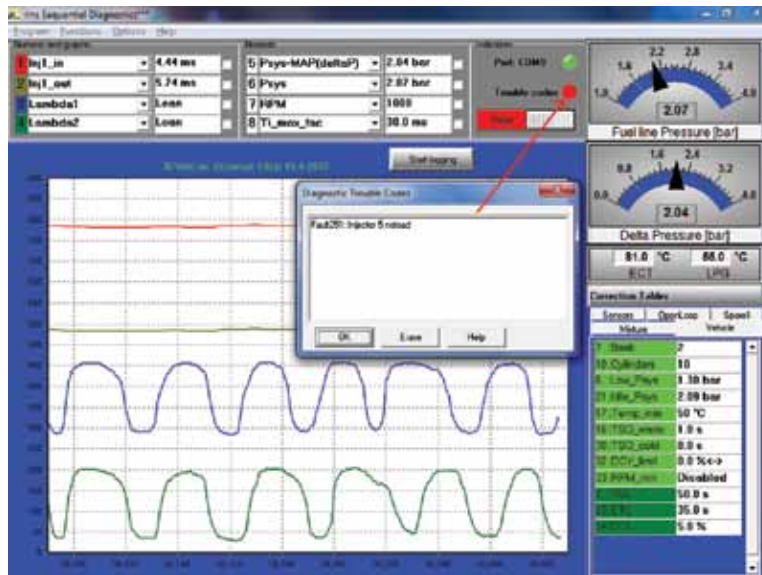

Figure 111. Fault code description box

**Note:** Each line on this screen may be customized by selecting the value shown.

Also notable on this screen:

- Line 1, Inj1\_in = the command signal from the vehicle's PCM to the Prins ECU.
- Line 2, Inj1\_out = the return signal from the Prins ECU to the autogas fuel injector. The calculation is the signal in, times the multiplier, plus any correction factors programmed into the Prins ECU.
- Line 3, Lambda1 = lambda sensor 1 status. Sensor 1 is always where cylinder 1 is, or the #1 spark plug.
- Line 4, Lambda2 = lambda sensor 2 status. Sensor 2 is the opposite side of #1.
- Line 5, Psys-MAP(deltaP) = pressure at the MAP sensor.
- Line 6, Psys = fuel system pressure
- Line 7, RPM = engine revolutions per minute.
- Line 8, Ti\_max\_fac = fuel load learning value, in milliseconds.

### 6.3.3 Fuel identification

*Driver Comment: “I can’t tell which fuel I’m using.”*

**The technician should explain the automated changeover process. Verify that the operator is waiting long enough between starting the vehicle and observing a switch-over to autogas.**

A vehicle with a properly operating autogas fuel system will perform almost transparently to gasoline. Vehicle operators may not be able to easily distinguish the difference between the two fuels.

The Prins system starts on gasoline by design. Then, when certain conditions are met, the vehicle automatically switches over to autogas. This ensures that any autogas in the vaporizer is in vapor form and not a partially atomized mist. As discussed in Chapter 1, propane expands in volume 270 times as it changes from liquid to vapor. Any liquid or partially vaporized propane, close to the saturation line, will be many times denser than propane vapor. When metered into the engine, fuel in this partially vaporized state will drastically alter the air-fuel ratio during cold starting and may cause irreparable damage to the exhaust catalytic converter or the fuel injectors.

This problem is solved by starting the engine on gasoline and then automatically switching over to autogas when the engine coolant reaches operating temperature and a preset amount of time has elapsed. These parameters are pre-programmed by the fuel-system manufacturer or set by the installer during the initial vehicle calibration. EPA-compliant fuel systems have these factors programmed into the ECU. They should not be altered unless approved by the fuel-system manufacturer or the manufacturer of record for the EPA certificate of conformity.

It is important to remember that the electrical selector switch located on the dash is also a diagnostic tool.

The Prins system requires three conditions to be met before the vehicle automatically switches from gasoline to autogas. The system cannot be forced to switch over from gasoline to autogas if these conditions are not met.

1. Time
2. Temperature
3. Fuel pressure

**Time.** If the fuel selector switch is set to run on autogas, the engine start sequence will always begin with gasoline and switch over in as little as one second when hot, or take as long as 4-5 minutes if ambient temperatures are very cold (see Temperature, below). These conditions are pre-set in the ECU but may be tailored by the installer to suit an individual vehicle if the emissions certification permits.

Figure 112, line 16, TSO\_warm (Time to Switch Over) indicates that the engine will switch from gasoline to autogas after one second when the engine is above 30-45°C.

Lines 17 and 30 show that the ECU is pre-set to switch over to autogas in 8 seconds when the engine is below 50°C. This switchover value may also be tailored by the installer to suit an individual vehicle if permitted by the emissions certification.

|               |          |
|---------------|----------|
| 7 :Bank       | 2        |
| 10 :Cylinders | 10       |
| 6 :Low_Psys   | 1.30 bar |
| 21 :Idle_Psys | 2.09 bar |
| 17 :Temp_min  | 50 °C    |
| 16 :TSO_warm  | 1.0 s    |
| 30 :TSO_cold  | 8.0 s    |
| 32 :DCY_limit | 0.0 %<-> |
| 33 :RPM_min   | Disabled |
| 2 :TOL        | 50.0 s   |
| 23 :ETL       | 35.0 s   |
| 24 :DOL       | 5.0 %    |

Figure 112. Initial programming screen

**Temperature.** Temperature is measured in two places, at the vaporizer and at the fuel filter pressure transducer. The sensor at the vaporizer shows the engine coolant temperature. The sensor at the fuel filter pressure transducer shows the temperature of the vaporized autogas.

The Prins fuel system requires engine coolant temperatures to be above 35°C (95°F) on a cold start, or above 45°C (113°F) on a hot restart. If the fuel pressure is below approximately 40 psig, the system may not automatically switch over. Verify that the ambient temperature is above -10°F to ensure sufficient vapor pressure at the tank.

If the ambient temperature is below approximately 0°F, there may not be enough pressure available at the fuel tank to supply the regulator. The switchover temperature is adjustable by the installer, but the values may be pre-determined by the emissions certificate.

**Fuel pressure.** Fuel pressure is measured at the fuel filter pressure transducer. If the fuel rail pressure is below approximately 11 psig or 750 mbar, the engine will not operate on autogas even if the other conditions are met. As shown on line 6, this is the minimum pressure at which the fuel system will switch from gasoline to autogas. Again, these values are adjustable by the installer but may be pre-determined by the emission certificate.

**Note:** If the red LED light on the dash selector switch is NOT illuminated, the vehicle will default to gasoline. Verify the Prins power fuse and ground circuit.

### 6.3.4 Gasoline consumption

*Driver Comment: “The vehicle keeps using gasoline even while operating on autogas.”*

**The technician should explain how the Prins starting process works.**

By design, the Prins fuel system will always start on gasoline. Depending on the ambient temperature conditions, the automated switchover process may take as long as 5 minutes, or the amount of time established in the Prins ECU programming. Gasoline is being used during this time. It is important to remember that the gasoline tank should be kept at least one-fourth to one-half full to minimize moisture condensation, and that the vehicle should NOT be allowed to run out of gasoline. Gasoline fuel pump damage can occur.

Operation on gasoline also maintains the emissions requirements of the EPA certificate of conformity. In this case, the gasoline tank canister purge sequence is activated during gasoline operation to remove any vapors from the gasoline tank.

Depending on the installation,<sup>1</sup> the gasoline fuel pump will continue to operate even while the system is running on autogas. This continual operation keeps the gasoline circulating and helps prevent the buildup of partially vaporized gasoline in the fuel rails and fuel injectors. The continual operation also allows for a smooth transition between autogas and gasoline by keeping the gasoline in the fuel injectors fresh and pressure primed.

Depending on the number of starting cycles, as much as 10 percent of total fuel consumption may be gasoline, or as little as 2 percent if the vehicle is driven primarily on the highway.

**Note:** If the fuel selector switch is manually changed to gasoline while in operation, the vehicle will restart and stay running on gasoline until it is manually switched back over to autogas. The vehicle will always operate on the fuel that was last selected.

**Note:** If the vehicle is operated in very cold climates, the initial and subsequent starting cycle switchover times may be extended. During this time, the vehicle will use gasoline.

<sup>1</sup> Gasoline fuel systems equipped with a variable speed fuel pump and a return-less fuel rail may utilize a fuel-pump simulation module. In this application, the fuel pump will be disconnected and the vehicle's ECM will see a simulated fuel-pump signal for emission maintenance and to prevent a check engine light.

### 6.3.5 No automatic switch to autogas

*Driver Comment: “The vehicle doesn’t automatically switch over to autogas.”*

**The technician must first verify that there is sufficient fuel in the tank.**

**If the red LED on the dash indicator switch is NOT illuminated:**

The first step should be to see if the LED at the dash indicator switch is illuminated, in Figure 113. This verifies that there is electrical current to the Prins ECU. If the LED is not illuminated, the system will default to gasoline. Verify that the 12-volt inline fuse near the battery is intact and that third-party electrical accessory or radio installers have not altered the Prins wiring.



Figure 113. Dash indicator switch

**If the LED on the dash indicator switch IS illuminated:**

Next, while operating in gasoline mode, depress the button on the dash indicator switch. A beep should be heard, signifying that the changeover is in progress. Also at this time, at least one green LED should be seen at the left-most of the four green LEDs. This means that the transition to autogas is in progress. The LED below the selector button should switch from gasoline to autogas.

If the red LED is illuminated AND the left green LEDs are illuminated and flashing, the vehicle may be out of autogas and reverted back to gasoline. A Diagnostic Trouble Code will be stored in the Prins ECU. The stored code will probably reference a low fuel pressure value. This is a hard code that requires the vehicle to automatically revert back to gasoline.

After verifying that enough fuel is in the tank, the next step is to inspect the fuel pressure transducer located on the fuel rail. Verify that the transducer is plugged in and that the wiring is not damaged.

Connect the diagnostic program and verify that no trouble codes are present, especially a #150 trouble code, insufficient fuel pressure. Also, check for codes #310, 320, 321 and 322, all of which relate to fuel pressure.



### 6.3.6 No manual switch to gasoline

*Driver Comment: “The vehicle has quit running on autogas, and I can’t manually switch over to gasoline.”*

If the operator has allowed the vehicle to run out of both autogas and gasoline, the vehicle will not start. This condition should be verified by observing the dashboard fuel-level gauge while on gasoline and verifying that the fuel selector switch is in the gasoline position. If available, add a small amount of gasoline and verify gasoline operation before performing any diagnostics on the autogas system. If the engine doesn’t operate on gasoline, it won’t operate on autogas.

Verify and remedy any gasoline operational faults before continuing diagnostics. Gasoline-related faults may include, but are not limited to:

- Fuel pump or filter (fuel pump, fuel pump relay)
- Ignition failure (crank or camshaft angle sensor, computer, wiring, ignition coil)
- Mechanical failure (camshaft timing belt or chain)

If the red LED and the green LED are blinking, a DTC should be stored. Verify that there is autogas in the tank. If a DTC is indicated, a malfunction will be indicated in the Prins system, and connection to the Diagnostic Software Program is required.

If the technician has the rights to access the ECU with a laptop, it is possible to temporarily adjust the fuel tables Line 30 TSO\_cold and Line 16 TSO\_warm to ZERO to force a cold engine start on autogas. Line 17 Temp\_min will have to be dropped below the ambient temperature.

**Note:** This procedure can only be performed on ECU software version D2.4.5 or older. Click on the Help tab in the pull-down menu and verify the software version.

**Note:** This procedure is a temporary diagnostic step. Once the vehicle has been diagnosed and repaired, the software fuel tables and temperature switchover settings should be returned back to the EPA-certified settings.

## 6.3.7 Stall on switchover

*Driver Comment: “The engine stalls on switchover.”*

One or more of the following symptoms may occur when the engine switches from gasoline to autogas. The symptoms may be intermittent or continuous.

- Engine stalling on switchover
- Engine stalling or switching back to gasoline on deceleration
- Engine surging at sustained acceleration or wide-open throttle
- Occasional misfire, especially during acceleration

These symptoms may be caused by an electrical fault, a programming fault or error, or insufficient or excessive delivery fuel pressure.

### **Electrical Fault**

To prevent these problems and ensure reliable performance, the crankshaft sensor must never be used as the RPM signal for the ECU. Always connect the VSI purple/white wire (#40) to a clean tachometer output, if available, or to a Hall-effect camshaft position sensor.

On Ford applications or any other vehicles with inductive camshaft sensors, use an RPM module (P/N: PRIN 091/0236) if a clean tachometer output signal is not available. Never connect the RPM wire directly to the coil negative (-) terminal. Irreversible damage will occur to the VSI ECU.

### **Programming Fault**

Connect the laptop and activate the diagnostic program. Verify that the fuel delivery pressures are at the required pressures. Correct as necessary.

### **Mechanical Fault**

Verify all mechanical connections at the vaporizer, including fuel delivery hoses, electrical connections and ground wire connections.

### 6.3.8 Lean or rich DTC

*Technician's Comment: "I have a consistent lean or rich emission fault code, but the vehicle runs and operates normally."*

#### **Possible Cause #1**

On some V-6, V-8 and V-10 engines equipped with Prins VSI systems, one cylinder bank may run leaner or richer than the opposite bank if one of the vapor hoses between the VSI filter assembly and the injector rails is exposed to more heat than the other one.

It is recommended that both hoses be routed in a similar fashion, away from excessive heat sources such as the exhaust manifold, cylinder heads and radiator. Always try to maintain the shortest distance between the filter assembly and the injector rails, and try to locate the filter assembly where the low-pressure vapor hoses to the injectors are of equal length.

#### **Possible Cause #2:**

If the fuel pressure creeps towards the maximum fuel pressure after adjustment, or if the fuel pressure is reset to the specified fuel pressure and is elevated upon retesting, the vaporizer may require service. The primary fuel pressure seat may have failed. Fuel pressure should be tested and recorded each time the vehicle's diagnostic program is used. This practice may help with long-term diagnostics by tracking the delivery pressure.

## 6.3.9 Automatic fuel switch during acceleration

*Driver Comment: “I had to accelerate at full throttle on autogas. Now the vehicle has switched over to gasoline and the dash indicator switch LED is blinking and beeping. It wouldn’t switch over to autogas until I turned the engine off and restarted.”*

**Note:** This problem will be more pronounced when the outside temperature is very cold.

### **Possible cause #1:**

If the driver tries to accelerate hard when the vehicle has just transitioned from gasoline to autogas, the engine coolant may be at borderline operating temperature. The sudden rush of fuel into a moderately warm vaporizer may temporarily chill the vaporizer below its switching threshold (35° to 45°C), which will force an automatic switchover to gasoline.

The vehicle will automatically switch to gasoline to prevent an erratic fuel mixture (partially vaporized liquid autogas) from damaging the catalytic converter. The fuel selector switch will indicate by beeping that the switch has occurred. A DTC may have been stored indicating low fuel pressure or low vaporizer temperature.

### **Possible cause #2:**

If the maximum RPM threshold has been reached, the fuel system will automatically switch back to gasoline. Also, during wide-open throttle operation, the fuel pressure may momentarily drop to its minimum Psys level and will automatically switch back to gasoline.

### 6.3.10 Gradual loss of power

*Driver Comment: “The vehicle gradually lost power while operating on autogas. The power loss became progressively worse. The vehicle then automatically switched to gasoline and can’t be switched back to autogas. The fuel selector switch is beeping.”*

#### **Possible cause #1**

The probable cause is a restricted fuel filter. The system has two filters. If the flow of fuel is sufficiently restricted through either of these filters, the secondary fuel-filter-mounted pressure transducer will detect the loss in pressure and force an automatic return to gasoline operation. This action prevents damage to the exhaust catalytic converter from to an excessively lean fuel mixture.

Connect the diagnostic software cable to the laptop and access the diagnostic program. If the fuel filter has become too restricted to operate, a diagnostic fault code #150 may have been set, indicating the fuel pressure is less than the minimum required.

The fuel filters should be replaced at the first 25,000 miles, then every 75,000 miles, or as indicated in the owner’s manual.

The primary filter is replaced by first closing the manual valve on the fuel tank and running the engine until it either quits running or switches over to gasoline. Attempt to restart to ensure that all the fuel pressure is depleted.



#### **Caution**

Do not operate the fuel system without both filters in place. Damage that is not covered under warranty may occur to the vaporizer and/or fuel injectors.

Fuel-filter replacement procedures differ, depending on which fuel-filter lockoff and primary fuel filter is used. Replace the fuel filter with a new element and re-pressurize. Test the repaired fuel filter to verify that there are no leaks.

The primary fuel filter is serviced by first closing the manual service valve at the fuel tank and carefully bleeding the fuel from the fuel line.

Figure 114 shows an installation with a fuel filter/fuel lockoff assembly not supplied by Prins. The fuel filter and lockoff are not part of the system's EPA emissions certification.



Figure 114. Prins vaporizer with primary fuel filter

The secondary filter, shown in Figure 115, is replaced by carefully removing the single bolt located in the end of the filter.

Separate the two sections and slip the filter out of the housing. Replace with the new filter and tighten the bolt "screwdriver tight."



Figure 115. Pressure and temperature transducer combined with the secondary fuel filter

The fuel filter may be cut open to analyze the contents that may have caused a restriction.

- A reddish powder may indicate rust that may have been washed loose by fuel moving around in the tank or transferred to the vehicle's fuel tank from a fuel-storage tank during refueling.
- A silver or gold residue may indicate debris from a failing transfer pump.
- Black, pepper-like residue may indicate that a fuel hose is delaminating internally. If so, the black debris will be resilient and crumble under light pressure.
- If the debris appears to be metallic (a magnet will stick to it), it is probably milling or tank welding slag that was dislodged by the movement of fuel during transit.

### **Possible cause #2**

Prins diagnostic software must be used to determine if a vaporizer pressure fault exists (i.e., outlet pressure too high or too low). The Prins system requires a minimum of 750mbar (12 psig) outlet pressure to operate. If the pressure is outside acceptable or programmed limits, the fuel system will default to gasoline.

Diagnostics should include a test drive at idle and under heavy acceleration. The fuel pressures should remain approximately the same. If the fuel pressure drops off significantly during acceleration, the fuel filters should be inspected and replaced if necessary.

### 6.3.11 Engine misfires

*Driver Comment: "The engine misfires when the headlamps are switched on."*

**Note:** This condition may develop whenever any significant electrical load is turned on, such as the air conditioner or defroster.

**Cause:**

Misfiring may occur if the vehicle has a weak ground connection and the electrical load is trying to find the next most efficient path to ground.

If the VSI ECU, shown in Figure 116, #50 (brown wire) is directly connected to the battery negative (-) post, problems may range from O<sub>2</sub> sensor misreading to generating a false trouble code, both on the OEM PCM and the VSI ECU.

It is recommended that no connections be made to the battery posts due to close proximity to battery acid and potential electrical cross-load. Verify that the 12V battery wire #51 (red) is properly connected to the battery (+) source at the relay or fuse panel, and the ground wire #50 (brown) is connected to good auxiliary ground, preferably where the battery negative cable is fastened to the body or engine, or at the shared computer ground at the engine block.

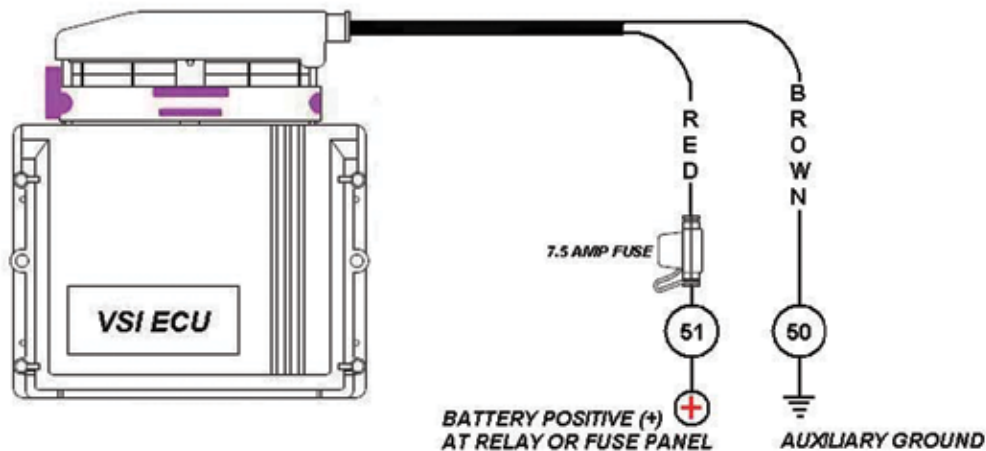

Figure 116. VSI system ECU



### 6.3.12 Out of gasoline

*Driver Comment: “The vehicle ran out of gasoline and won’t start.”*

This condition may occur if the driver forgot to fill the gasoline tank or if an automated fleet-management system prevented the gasoline tank from being filled completely due to fuel-usage policies.<sup>2</sup>

#### **Explain the Prins system’s fuel-usage requirements.**

It is recommended to keep at least 1/4 tank of gasoline available at all times.

The Prins fuel system uses gasoline for a short time at every engine start or restart. Gasoline usage may be as low as a few percent, or as much as 100 percent if the fuel-selector switch is kept in the gasoline position.

The system cannot be force-started on autogas if the vehicle runs out of gasoline or has a fuel-delivery problem that prevents the engine from running on gasoline.

If the technician has the rights to access the ECU with a laptop, it is possible to temporarily adjust the fuel tables, Line 30 TSO\_cold and Line 16 TSO\_warm, to ZERO. Line 17, Temp\_min, will have to be dropped below the ambient temperature.

**Note:** This operation can only be performed on ECU software version D2.4.5 or older. Click on the Help tab in the pull-down menu and verify the software version.

To comply with the emission certification, the programming **MUST** be returned to the original setting after the gasoline operation has been repaired or restored.

<sup>2</sup> Some automated fleet-management systems or policies may allow only a fixed amount of gasoline to be used in a specific period, e.g., 5 gallons per week or month, or 10 percent of the total fuel used per refill, to encourage the use of alternative fuels.

### 6.3.13 No operation after refueling

*Driver Comment: “I just refueled on gasoline, and now the vehicle won’t run properly (or won’t run at all) on autogas.”*

The technician should verify that this problem sequence is exactly as described and that the vehicle ran normally until this event occurred. The Prins fuel-management system uses the original gasoline fuel system’s injection calculations. Any alteration to those calculations may cause the autogas system to go out of calibration.

The technician should verify that the driver did NOT refuel with E-85, which is a mixture of 85 percent ethanol and 15 percent gasoline.

Many current vehicles are flex-fuel, meaning they can operate on mixtures of ethanol and gasoline in any proportion. When a flex-fuel vehicle is converted to autogas with a Prins fuel system, the vehicle may use only gasoline that contains up to 10 percent ethanol. To maintain its ability to use autogas, the vehicle should not be operated on E-85.

The reason is that E-85 falls outside the fuel-mapping limits of the Prins ECU. The original vehicle’s oxygen sensor feeds back information on the exhaust composition to the original PCM. When the vehicle has been fueled with E-85, the gasoline program that was stored in the original PCM is too lean for E-85 operation. The oxygen sensor detects the lean exhaust mixture and allows the adaptive memory tables in the ECU to modify the gasoline fuel programming to recognize the fuel mixture until it achieves the proper stoichiometric mixture for E-85.

This can be recognized by observing the Short Term Fuel Trim (STFT) values with an OBD-II scan tool. Standard OBD-II adaptive-learn policies typically limit adaptive fuel trimming to approximately 25 percent to 35 percent lean or rich from the “0” value, also called the “threshold limit.” E-85 expands the threshold limit to as much as 50 percent. This expansion is outside of the Prins VSI’s fuel-mapping range. The industry calls this “active fuel management,” which means that the vehicle’s PCM is always monitoring the fuel-system inputs and controlling the fuel mixture for optimum performance and emissions.

If a flex-fuel vehicle is inadvertently filled with E-85, the recommendation is to operate the vehicle solely on E-85 until the tank is depleted, then run one full tank of standard unleaded 87-octane gasoline containing no more than 10 percent ethanol before switching back to autogas, to allow the gasoline PCM to recalibrate itself to the autogas-adaptable program.



### **Caution**

If the vehicle is not E-85 capable, E-85 fuel must be removed immediately to prevent permanent damage to the fuel tank, fuel pump, fuel injectors and fuel-pressure regulators. The vehicle should then be immediately refueled with unleaded gasoline and operated for one full tank without switching over to autogas.

### 6.3.14 Inaccurate fuel-level gauge

*Driver Comment: “My dashboard gauge doesn’t read the autogas fuel level accurately.”*

The technician should explain that the fuel-level gauge on an autogas tank is not a true representation of the fuel level inside the tank and should not be used during refueling or to calculate fuel consumption.

The fill level inside an autogas fuel tank is measured with a float that operates a magnetically coupled dial gauge mounted outside the tank. Attached to that dial gauge is a variable transducer or resistor that is designed to replicate the original dash gauge, if used. Other vehicle installations may utilize the LED lights on the fuel selector switch as the fuel level gauge, with each light indicating ¼ tank level increments.

The Prins fuel system switches from autogas to gasoline at a pre-programmed point. This point is determined in part by the gasoline fuel-level gauge, which typically plays a part in the OEM vehicle’s emission-control strategy by correlating fuel consumption with canister purge sequencing. For this reason, the Prins ECU is programmed to require at least one fuel-level LED to remain illuminated while the vehicle is running on autogas.

The volume of autogas liquid is also sensitive to temperature. From a reference point of 60°F, propane expands or contracts about 1 percent for every 6°F increase or decrease in temperature, respectively. If a tank is filled during a hot day and the level observed that night after the weather turns cold, the fuel level can be significantly different. During the fall and spring outside temperatures can vary as much as 40°F, which can result in a 6 percent change in fuel volume and a corresponding change in the level of fuel in the tank.

When the vehicle starts on gasoline, the OEM dash fuel gauge may automatically read the gasoline level if the vehicle was wired to the original dash gauge. As the vehicle transitions to autogas, the OEM dash fuel level gauge may slowly transition to indicate the autogas fuel level (again, if the OEM dash gauge is wired to the autogas tank).

This transition may take as long as 30 minutes to fully display the recorded autogas fuel level. When the vehicle returns to gasoline operation, either by automatic or manual switchover, the gauge again transitions slowly to indicate the gasoline fuel level. The dash gauge movement is buffered because the original PCM sets the charcoal canister purge sequencing and duration based on the fuel level.

## Prins Vapor Sequential Injection System

If the vehicle was not wired to the dash gasoline fuel-level gauge, the vehicle's PCM may set a fuel-level gauge DTC due to an improper correlation between the fuel usage and the dash gauge. A gasoline fuel level of approximately  $\frac{1}{4}$  to  $\frac{1}{2}$  tank will keep the gasoline fuel tank sending unit float moving, which may satisfy the OEM PCM. If not, the autogas fuel-level sending unit may need to be wired through to the OEM dash gauge.

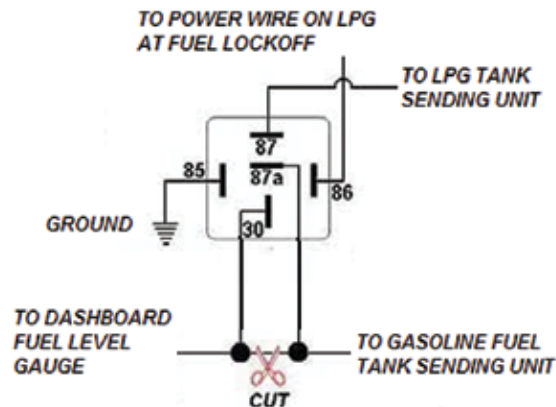

Figure 117. Relay to connect the autogas tank to the OEM dash gauge

Figure 117 shows the schematic to wire in an auxiliary relay that connects the autogas tank's sending unit to the OEM dash gauge. It is critical to install the correct sending unit, since vehicle OEMs use units with different resistance values during the same model year or on different vehicles in the same model year.

### 6.3.15 Check engine light

*Driver Comment: “My check engine light came on, but the vehicle seems to be running normally. What’s wrong?”*

First, never assume that a dashboard indicator light means there is a fault in the autogas fuel system, even though the diagnostics are integrated. The check engine light (also known as an MIL or Malfunction Indicator Light) can be triggered by a number of vehicle faults, including in some cases improper tire size (which might trigger an ABS fault), low tire pressure, overheated catalyst, inoperable cooling fan, loose gas cap, defect in the canister purge sequence, over-rev or over-speed, or engine misfire.

The first step to isolate the problem is to connect an OBD-II scan tool to the vehicle’s diagnostic port and observe the OEM diagnostic codes. These codes may indicate a fault that, if autogas-related, may also be stored in the Prins ECU. Remember that the Prins ECU reads the original vehicle’s PCM. Any codes caused by either fuel system, including codes that are not specific to the Prins system, will also be stored in the vehicle’s PCM. Autogas-related fault codes will be stored in the Prins ECU, but gasoline fault codes will only be stored in the vehicle’s PCM.

#### EXAMPLE: LEAN MIXTURE

Connect an OBD-II scan tool. If a P0171 or P0174 code is detected, observe the Short Term Fuel Trim values. These codes indicate a lean fuel mixture. The STFT values should indicate a positive number, for example, a STFT = +10, or 10 percent more fuel added to the calculated fuel mixture table.

Using the mixture table at right in Figure 118, adjust line #3 from 120% to 125% and observe the fuel trim table on the OBD-II scan tool.

Adjusting line #3 changes the amount of autogas fuel calculated from the original gasoline fuel mixture calculation.

Note that Prins recommends setting the RC\_inj at 115% for the initial setup.

|                |       |
|----------------|-------|
| 22 :System     | LPG   |
| 3 :RC_inj      | 120 % |
| 4 :Off_inj     | 10    |
| 28 :Lcor       | 0.0 % |
| 29 :Lcor_cycle | 0     |

Figure 118. Lean mixture RC\_inj

### EXAMPLE: RICH MIXTURE

Connect an OBD-II scan-tool. If a P0172 or P0175 code is detected, observe the Short Term Fuel Trim values. These codes indicate a rich fuel mixture. The STFT values should indicate a negative number (for example, a STFT = -10, or 10 percent more fuel reduced from the calculated fuel mixture table.

Using the mixture table at right in Figure 119, adjust line #3 from 100% to 95% and observe the fuel trim table on the OBD-II scan tool.

|                |       |
|----------------|-------|
| 22 :System     | LPG   |
| 3 :RC_inj      | 100 % |
| 4 :Off_inj     | 0     |
| 28 :Lcor       | 0.0 % |
| 29 :Lcor_cycle | 0     |

Figure 119. Rich mixture RC\_inj

Adjusting line #3 changes the amount of autogas fuel calculated from the original gasoline fuel-mixture calculation.

Adjusting line #4 for idle and low partial load speeds helps keep the STFT values at the desired value of  $\pm 3\%$ .

### Possible reasons to shift the percentage value:

1. Deteriorating gasoline fuel-system condition, since the autogas fuel system monitors the gasoline fuel-system values and calculates the necessary correction value.
2. Deteriorating gasoline engine condition, e.g., engine wear.
3. O<sub>2</sub> sensor contamination.

**INSTALLER'S TIP:** It is highly unusual to enter a lower fuel injector offset calculation (i.e., less than 100 percent). If this condition is experienced, the technician should perform a thorough gasoline fuel-system analysis. The analysis should include testing the pressure regulator for leakage or other malfunction, checking for leaking gasoline fuel injectors, evaporative canister purge function, or anything else that might allow unmetered gasoline into the engine where it might alter the oxygen-sensor readings.

### 6.3.16 Special spark plugs

*Driver Comment: “I was told to use special spark plugs. Why is that required and how often should I change them?”*

Unless specially identified in the EPA or CARB emission certificate of conformity, the only spark plugs installed should be those originally specified by the OEM.

In early autogas vehicle conversions, spark plugs were frequently gapped closer than the OEM plugs to help prevent backfires. Since spark plugs with a smaller gap do not require as intense a secondary ignition current, the ignition coils would last longer, and before distributors and distributor caps became obsolete, they would last longer, too. Current coil-over spark ignition systems have a stronger secondary ignition that can easily ignite autogas fuel mixtures.

The Prins-managed autogas fuel mixture is closely matched to the original gasoline fuel mixture and is less demanding on the ignition system than early mechanical carbureted autogas systems. Since the fuel system must be EPA-certified to an emission standard that is at least as clean as the original vehicle, the fuel mixtures stay in closer trim for a longer period.

Older autogas aftermarket conversion facilities also changed the spark plugs from platinum tip or iridium tip to copper core; however, no conclusive tests have shown that any spark plug is superior to the one that was originally installed. Changing from these premium spark plugs to a copper-core spark plug may also shorten the plug change interval from as high as 100,000 miles to less than 25,000 miles in some cases.



### 6.3.17 Erratic fuel switching

*Driver Comment: “The vehicle switches back and forth rapidly between autogas and gasoline.”*

If any of the three conditions (time, temperature or pressure) is outside programmed limits, the vehicle will switch over to the other fuel. The diagnostic technician should verify the electrical connections at each of the sensors and the mechanical condition of the engine.

Problems that may contribute to rapid fuel-switching include, but are not limited to:

- **Low engine coolant level.** If the engine coolant is below the minimum level, the vaporizer may not heat properly or the engine may periodically splash warm coolant to the vaporizer, causing an erratic temperature-sensor reading.
- **Loose wire connection.** Check the connections at any installed sensors, fuel lockoffs, selector switches, system ground circuits, or partially dislodged pins in the ECU main wire harness connector. Verify that the fuse holders are electrically and mechanically secure.
- **Fuel pressure.** Fuel pressure must be at or near the minimum temperature level. If the throttle is opened when the fuel pressure is low due to low ambient temperatures, the vaporizer may cycle between the pre-set minimum pressure set-points.

## Review of Chapter 6, Prins VSI System

Directions: Select from the list below the response which most correctly completes each of the following statements. Write the letter of your choice in the space provided.

- |                    |                          |
|--------------------|--------------------------|
| A. gas pressure    | I. bar                   |
| B. selector switch | J. time                  |
| C. same length     | K. gasoline              |
| D. OBD-II          | L. operating temperature |
| E. DTC             | M. bifuel                |
| F. annually        | N. 15,000                |
| G. RC_inj          | O. coolant temperature   |
| H. canister purge  | P. injector nozzles      |

- \_\_\_\_\_1. The Prins VSI fuel system is designed to operate as a \_\_\_\_\_ system.
- \_\_\_\_\_2. When performing the fuel pressure test, the engine must be at \_\_\_\_\_.
- \_\_\_\_\_3. To allow the \_\_\_\_\_ to operate, the gasoline fuel level gauge may be used.
- \_\_\_\_\_4. The \_\_\_\_\_ determines the injector offset percentage, i.e., the amount of increase in the pulse width of the gasoline injector.
- \_\_\_\_\_5. To change from gasoline to autogas, the \_\_\_\_\_ is depressed.
- \_\_\_\_\_6. The intake manifold is modified to accept \_\_\_\_\_.
- \_\_\_\_\_7. Fuel pressure should be checked/adjusted \_\_\_\_\_.
- \_\_\_\_\_8. Since 1996, all automobiles and light-duty trucks sold in the U.S. must comply with which diagnostic standard?
- \_\_\_\_\_9. If an injector connection hose must be replaced, the new hose must be the \_\_\_\_\_ as the original hose.
- \_\_\_\_\_10. The Prins VSI fuel system is designed to start on \_\_\_\_\_.
- \_\_\_\_\_11. Fuel filters should be replaced every \_\_\_\_\_ miles.

## Prins Vapor Sequential Injection System

- \_\_\_\_ 12. Before the Prins VSI system switches from gasoline to autogas, which three conditions must be in agreement? 12 \_\_\_\_\_, 13 \_\_\_\_\_, and 14 \_\_\_\_\_.
- \_\_\_\_ 13.
- \_\_\_\_ 14.
- \_\_\_\_ 15. To aid in diagnostics, the original vehicle's PCM is used to read the \_\_\_\_\_.
- \_\_\_\_ 16. The fuel pressure reading is shown as \_\_\_\_\_ .

Answer key: 1-M, 2-O, 3-H, 4-G, 5-B, 6-P, 7-F, 8-D, 9-C, 10-K, 11-N, 12-J, 13-L, 14-A, 15-E, 16-I



# ***Chapter Seven***

***Malfunction Indicator  
Lights: OEM And LPG***

## CHAPTER 7: MALFUNCTION INDICATOR LIGHTS: OEM AND LPG

### 7.1 MIL Illuminated

*Driver Comment: “My dashboard malfunction indicator light is on. The propane shop tells me this light is OEM-related. The dealership tells me it is related to the autogas system. Who is right?”*

Since OBD-II became mainstream in 1996, all OBD-II diagnostic functions that operate in gasoline mode must be stored until they are either erased or until a predetermined number of vehicle starting cycles have occurred with no recurrence of the fault. Fuel systems in use at that time lacked the ability to interface with the OBD-II. Since 2004 EPA has required OBD-II diagnostic functions to also relay what is happening with the propane autogas fuel system. If an emission-related DTC occurs on a bifuel application, the autogas system must immediately default to gasoline mode.

The technician should remember that DTCs occur on vehicles that have not been converted and that stored DTCs are not necessarily related to autogas operation, even if the vehicle was running on autogas at the time.

The technician should never assume that a dashboard indicator light means that there is an autogas fuel system fault, even though the diagnostics of the gasoline and autogas systems are integrated. An MIL may be triggered by a number of vehicle faults, including in some cases, improper tire size (which might trigger an ABS fault), low tire pressure, overheated catalyst, inoperable cooling fan, loose gas cap, defect in the canister purge sequence, engine misfire, over-rev or over-speed.

The first diagnostic step is to verify the DTC that is stored in the OEM computer. The recorded DTC may not identify which fuel or fuel system is being used or how it interfaces with the OEM PCM. Not all fuel systems interface the same way, but all fuel systems must interface with OBD-II. If the DTC indicates a lean fuel mixture on bank one, it does not matter which fuel is in use: the fuel mixture on bank one IS lean.

### Diagnostic Trouble Codes

#### First Digit – System

The first character in a DTC identifies the system.

- P = Power train
- B = Body
- C = Chassis
- U = Undefined

#### Second Digit – Code Type

The second digit identifies whether the code is a generic code (same on all OBD-II equipped vehicles), or a manufacturer-specific code.

- 0 = Generic (this is the digit zero, not the letter “O”)
- 1 = Enhanced (manufacturer specific)

#### Third Digit – Subsystem

The third digit denotes the subsystem.

- 1 = Emission management (fuel or air)
- 2 = Injector circuit (fuel or air)
- 3 = Ignition or misfire
- 4 = Emission control
- 5 = Vehicle speed and idle control
- 6 = Computer and output circuit
- 7 = Transmission
- 8 = Transmission
- 9 = SAE reserved
- 0 = SAE reserved

## Fourth and Fifth Digits

These digits are variable and relate to a particular problem.

For example, a “P0171” code means

- P = Power train
- 0 = Generic
- 1 = Emission-related
- 7 = Fuel mixture issue
- 1 = Identifier

This code indicates that the engine is operating too lean on the bank where the #1 spark plug is located. Bank one is also the cylinder head that sits the most forward. Bank one should not be confused with “side one.” B1S1 means “Bank One, Sensor One,” referring to the first oxygen sensor located in the exhaust manifold of bank one. B1S2 means the second oxygen sensor in bank one, usually located in the catalytic converter.

The most likely autogas-related generic OBD-II codes are:

- P0171 System too lean (Bank 1)
- P0172 System too rich (Bank 1)
- P0173 Fuel trim malfunction (Bank 2)
- P0174 System too lean (Bank 2)
- P0175 System too rich (Bank 2)
- P04## Indicating an evaporative emission fault (there are more than 30 evaporative emission faults)

These are not the only codes. Some fuel systems reprogram the PCM and repurpose some sensors for other uses. For example, on the Roush CleanTech LPI liquid propane injection system, the canister evaporative purge sequence is disabled and cannot set an evaporative DTC. Follow conventional OBD-II DTC diagnostic strategies.

## 7.2 General Maintenance

- The entire system should be inspected annually for chafing, loose parts and leaks.
- The fuel filter should be replaced at 60,000 miles.
- The STFT and LTFT should be recorded annually for the detection of possible fuel mixture trends.



---

# ***Appendices***

## APPENDIX A: GLOSSARY

Some terms and definitions used in this module reference National Fire Protection Association (NFPA) Pamphlet 58, *Liquefied Petroleum Gas Code*, 2008 edition. The list below is not exhaustive and covers only the terms used in this module and terms commonly used in the autogas industry.

**Note:** Components used in some fuel systems may be of European origin, and the manufacturer's literature or diagnostic software may use European units or references.

### Air-Fuel Ratio

The ratio of air to fuel in a mixture, expressed either by volume or by weight. For propane, the ideal air-fuel ratio by volume is 24:1, i.e., 24 parts air to 1 part fuel. The ideal ratio by weight is 15.5:1, i.e., 15.5 pounds of air to 1 pound of fuel. An air-fuel ratio may be expressed as an AF number. In this system, the ideal ratio is defined as  $AF = 1$ . An AF ratio greater or less than 1 indicates a rich or lean mixture, respectively. AF 1.1 means the mixture is 10 percent richer than the ideal ratio, and AF 0.9 means the mixture is 10 percent leaner than the ideal ratio. See also Lambda.

**ALDL** Assembly Line Diagnostic Link. The connection located near the steering column that allows OBD-II access to the vehicle's electronic control module.

**ANSI** American National Standards Institute. ANSI sets standards that are adopted by various authorities having jurisdiction. ANSI does not develop, manufacture, or market components, equipment, or processes, only the standards by which they are designed. NFPA 58, §3.3.3

**ASME** American Society of Mechanical Engineers. ASME sets manufacturing standards for propane autogas fuel containers. NFPA 58, §3.3.6

**Autogas** The international term for LP-gas mixtures used to propel highway vehicles. In the U.S., autogas is at least 90 percent propane, and the terms "autogas," "propane," and "propane autogas" are used interchangeably. Elsewhere "autogas" may refer to mixtures of propane and butane in various proportions. See also HD-5.

**BAR** Unit of pressure. One bar = one atmosphere, or approximately 14.7 pounds per square inch. One millibar (mbar) = 1/1,000th bar.

**Bifuel** A vehicle capable of operating on either of two fuels, but not at the same time, e.g., autogas or gasoline. See Dual Fuel.

- CARB** California Air Resources Board, sometimes abbreviated ARB. The state agency that sets emissions standards for vehicles in California. Any converted vehicle bought or sold in California must meet CARB emissions standards. Some other states adopt CARB emissions standards.
- Converter** Generic term for a device that converts propane liquid to propane vapor and incorporates a pressure regulator that reduces tank pressure to the pressure required by the engine. The term is sometimes used interchangeably with vaporizer, reducer, regulator or vaporizing regulator. See Vaporizer.
- DCY-petrol** Prins VSI system code for the gasoline/rpm injection time.
- DCY-gas** Prins VSI system code for the propane autogas/rpm injection time.
- DTC** Diagnostic Trouble Code. Generic term for a code sent from a vehicle's electronic control module indicating a specific malfunction in the vehicle's emissions control system. The code may be cross-referenced to help identify the fault. See ECM/PCM/ECU.
- Dual Fuel** A vehicle capable of operating on a mixture of two fuels at the same time, e.g., autogas and diesel. See Bifuel.
- ECM/PCM/ECU**  
Electronic Control Module, Powertrain Control Module, and Electronic Control Unit, respectively. The terms are interchangeable and do not identify a manufacturer or brand-specific component. An ECM/PCM/ECU controls all engine functions, including emission controls and throttle position. Some aftermarket fuel systems use a supplemental module as an interceptor or translator. Dedicated liquid propane fuel injection systems typically use the original PCM, repurposed for propane.
- EPA** U.S. Environmental Protection Agency. EPA oversees the testing and certification of engine fuel systems to verify compliance with applicable emissions standards. Vehicles converted to propane must comply fully with the EPA emissions regulations in effect at the time of the conversion.
- Flash / Re-Flash**  
To program or re-program an ECU.
- Gas** A substance in the gaseous (vapor) phase. In international usage, a gaseous fuel, such as propane autogas.
- GAS-COR** Prins VSI system code for correction of the injection time based on the gas temperature and pressure and the correction of any gasoline enrichment.

**HD-5** A specification for propane autogas. “HD” means heavy duty, and “5” means no more than 5 percent propylene by volume is permitted in the fuel mixture. HD-5 propane typically conforms to ASTM 1835, which specifies a maximum of 5 percent propylene, a minimum of 90 percent propane, and the remainder trace gases. A maximum vapor pressure of 208 psig at 100°F effectively limits the amount of higher-pressure ethane in the mixture.

**HD-10** Unofficial term for liquefied petroleum gas with up to 10 percent propylene that meets the specifications set out in the California Code of Regulations, Title 13, Section 2292.6.

### Heavy Ends

Semi-soluble compounds present in commercial grade and HD-5 propane. During refining it is economically impractical to remove all partially distilled oils and heavier hydrocarbons. When propane is vaporized inside a vaporizer or converter, partially vaporized heavier compounds may be left behind in the form of light oils, heavier greases or paraffins.

**KOEO** Key On, Engine Off. A diagnostic step that allows testing of components with the key on but the engine not running.

**KOER** Key On, Engine Running. A diagnostic step that allows testing of components with the key on and the engine running.

**Lambda** A measure of a fuel mixture’s air-to-fuel ratio, represented by the Greek letter lambda ( $\lambda$ ).  $\lambda=1.0$  means an ideal air-fuel ratio. NOTE: Lambda values are the reverse of AF ratios.  $\lambda=1.1$  means the mixture has 10 percent excess air, i.e., is leaner than ideal.  $\lambda=0.9$  means the mixture has 10 percent too little air, i.e., is richer than ideal. See Air-Fuel Ratio; Stoichiometry.

### Lambda sensor

Synonym for oxygen ( $O_2$ ) sensor. Measures residual oxygen in the exhaust after combustion.

### Manufacturer of record

The entity that files and “owns” a vehicle’s EPA-issued certificate of emissions conformity. The manufacturer of record may be the fuel system manufacturer or the installer.

**LPG** Liquefied Petroleum Gas. Any material having a vapor pressure not exceeding that allowed for commercial propane that is composed predominantly of the following hydrocarbons, either by themselves or as a mixture: propane, propylene, butane (normal or iso-butane) and butylene. NFPA 58, §3.3.36

**LPI, LPFI** Liquid Propane Injection, Liquid Propane Fuel Injection. A technology in which propane liquid instead of propane vapor is injected into the intake manifold of an engine. See LPFFI.

**LPFFI** Liquid Phase Propane Fuel Injection. See LPI, LPFI.

### **Mass Air Flow (MAF)**

The amount of air entering the engine, measured by weight. A MAF sensor calculates the mass of the incoming air based on variables such as inlet air temperature, air pressure, relative humidity and engine speed to trim the engine's air-fuel ratio.

**MIL** Malfunction Indicator Light. An amber dashboard light indicating that service is needed but the fault is not an emergency. Also known as the Check Engine Light or the Service Engine Soon light.

**MSDS** Material Safety Data Sheet. A document that describes the physical and chemical properties of a product and provides health and safety information related to the product's storage, use and disposal. See Appendix B.

**NFPA** National Fire Protection Association. NFPA publishes codes and standards that are adopted by many U.S. jurisdictions. NFPA 58, Liquefied Petroleum Gas Code, includes standards on propane retrofit fuel systems.

**Odorant** A man-made compound added to fuel gas to aid in leak detection. The most commonly used odorant is ethyl mercaptan (ethanethiol), a sulfur-based compound that smells like rotten eggs. NFPA 58 states that odorization at the rate of 1 pound of ethyl mercaptan per 10,000 gallons of propane has been recognized as an effective odorant.

**Petrol** European term for gasoline.

**Propane** One of the four regulated liquefied petroleum gases: propane, propylene, normal butane and iso-butane. The term "propane" is often used to refer to a mixture of LP gases that is predominantly propane. See Autogas.

### **Saturation Pressure**

The minimum pressure required at a given temperature to keep propane in the liquid phase. If the pressure is reduced or the temperature increases, propane will vaporize and seek to return to its saturation pressure. If the pressure is increased or the temperature decreases, propane will remain a liquid. See Vapor Pressure.

### **Speed Density**

The calculation used for determining the air-fuel ratio based on engine rpm, engine displacement and manifold vacuum.

**STFT/LTFT** Short Term Fuel Trim / Long Term Fuel Trim. Fuel trim refers to the continual adjustment of an engine's air-fuel ratio by the vehicle's powertrain control module. STFT refers to adjustments made in response to temporary conditions. LTFT refers to longerterm adjustments. Trim values are used during diagnostics to determine how the vehicle has been performing or to program the auxiliary PCM.

Fuel trim values are expressed in percentages. Positive fuel trim values indicate adjustments for a lean mixture (added fuel). Negative fuel trim values indicate adjustments for a rich mixture (subtracted fuel). LTFT values generally should not exceed  $\pm 10$ -25 percent, or the vehicle's computer may set a fault code.

### **Stoichiometry**

SAE standard J1829 defines "stoichiometric air-fuel ratio" as "the mass of air required to burn a unit mass of fuel with no excess of oxygen or fuel left over." An engine running at AF=1 or at Lambda ( $\lambda$ )=1 is operating at stoichiometry. See Air-Fuel Ratio; Lambda.

**T-ECT** Prins VSI system code for engine coolant temperature.

**T-GAS** Prins VSI system code for autogas fuel temperature, as measured at the fuel filter and pressure sensor.

**T-GAS-min** Prins VSI system code for minimum autogas fuel temperature, i.e., the minimum temperature at which autogas may be selected for operation.

**TSO** Prins VSI system code for Time to Switch Over. The amount of time allowed between automatic switchovers from gasoline to propane autogas.

### **Vapor Pressure**

Another term for saturation pressure.

**Vaporizer** The most common term for the device in a propane autogas fuel system that converts liquid fuel to vapor. See Converter.

# APPENDIX B: MATERIAL SAFETY DATA SHEET

## Material Safety Data Sheet

### Odorized Propane

#### 1. CHEMICAL PRODUCT AND COMPANY IDENTIFICATION

**Product Name:** Odorized Commercial Propane  
**Chemical Name:** Propane  
**Chemical Family:** Hydrocarbon  
**Formula:** C<sub>3</sub>H<sub>8</sub>  
**Synonyms:** Dimethylmethane, LP-Gas, Liquefied Petroleum Gas (LPG), Propane, Propyl Hydride  
**Transportation Emergency No.:** 800/424-9300 (CHEMTRAC)

Material Safety Data Sheet – Odorized Propane

**1. CHEMICAL PRODUCT AND COMPANY IDENTIFICATION**

Product Name: Odorized Commercial Propane  
 Chemical Name: Propane  
 Chemical Family: Hydrocarbon  
 Formula: C<sub>3</sub>H<sub>8</sub>  
 Synonyms: Dimethylmethane, LP-Gas, Liquefied Petroleum Gas (LPG), Propane, Propyl Hydride

Transportation Emergency No.: 800/424-9300 (CHEMTRAC)      Emergency Number:

**2. COMPOSITION/INFORMATION ON INGREDIENTS**

| INGREDIENT NAME / CAS NUMBER | PERCENTAGE | OSHA PEL |
|------------------------------|------------|----------|
| Propane / 74-98-6            | 87.5-100   | 1000 ppm |
| Ethane / 74-84-0             | 0-7.5      |          |
| Propylene / 115-07-1         | 0-10.0     |          |
| Butanes/various              | 0-2.5      |          |
| Ethyl Mercaptan / 75-08-1    | 16-25 ppm  | 0.5 ppm  |

**3. HAZARDS IDENTIFICATION**

**EMERGENCY OVERVIEW**  
**DANGER!** Flammable liquefied gas under pressure. Move away from heat, sparks, flames, and all other ignition sources. Vapor replaces oxygen available for breathing and may cause suffocation in confined spaces. Use only with adequate ventilation. Odor may not provide adequate warning of potentially hazardous concentrations. Vapor is heavier than air. Liquid can cause freeze burn similar to frostbite. Do not get liquid in eyes, on skin, or on clothing. Avoid breathing of vapor. Keep container valve closed when not in use.

**NFPA 704 Hazard Identification System**

**POTENTIAL HEALTH EFFECTS INFORMATION**  
**ROUTES OF EXPOSURE:** Inhalation. It should be noted that before sufficient could occur, the lower flammability limit of propane is 2.1% by volume in air.

#### 2. COMPOSITION/INFORMATION ON INGREDIENTS

| INGREDIENT NAME / CAS NUMBER | PERCENTAGE | OSHA PEL |
|------------------------------|------------|----------|
| Propane / 74-98-6            | 87.5-100   |          |
| Ethane / 74-84-0             | 0-7.5      | 1000 ppm |
| Propylene / 115-07-1         | 0-10.0     |          |
| Butanes/various              | 0-2.5      |          |
| Ethyl Mercaptan / 75-08-1    | 16-25 ppm  | 0.5 ppm  |

#### 3. HAZARDS IDENTIFICATION

##### EMERGENCY OVERVIEW - NFPA 704 - Hazard Identification System

**DANGER!** Flammable liquefied gas under pressure. Keep away from heat, sparks, flame, and all other ignition sources. Vapor replaces oxygen available for breathing and may cause suffocation in confined spaces. Use only with adequate ventilation. Odor may not provide adequate warning of potentially hazardous concentrations. Vapor is heavier than air. Liquid can cause freeze burn similar to frostbite. Do not get liquid in eyes, on skin, or on clothing. Avoid breathing of vapor. Keep container valve closed when not in use.



## POTENTIAL HEALTH EFFECTS INFORMATION

### Routes of Exposure:

**Inhalation:** Asphyxiant. It should be noted that before suffocation could occur, the lower flammability limit of propane in air would be exceeded, possibly causing both an oxygen-deficient and explosive atmosphere. Exposure to concentrations >10% may cause dizziness. Exposure to atmospheres containing 8%-10% or less oxygen will bring about unconsciousness without warning, and so quickly that the individuals cannot help or protect themselves. Lack of sufficient oxygen may cause serious injury or death.

**Eye Contact:** Contact with liquid can cause freezing of tissue.

**Skin Contact:** Contact with liquid can cause frostbite.

**[Skin Absorption]:** None.

**[Ingestion]:** Liquid can cause freeze burn similar to frostbite. Ingestion not expected to occur in normal use.

**Chronic Effects:** None.

**Medical Conditions Aggravated by Overexposure:** None.

**Other Effects of Overexposure:** None.

**Carcinogenicity:** Propane is not listed by NTP, OSHA or IARC.

## 4. FIRST AID MEASURES

### INHALATION:

Persons suffering from lack of oxygen should be removed to fresh air. If victim is not breathing, administer artificial respiration. If breathing is difficult, administer oxygen. Obtain prompt medical attention.

### EYE CONTACT:

Contact with liquid can cause freezing of tissue. Gently flush eyes with lukewarm water. Obtain medical attention immediately.

### SKIN CONTACT:

Contact with liquid can cause frostbite. Remove saturated clothes, shoes and jewelry. Immerse affected area in lukewarm water not exceeding 105°F. Keep immersed. Get prompt medical attention.

**INGESTION:** If swallowed, get immediate medical attention.

**NOTES TO PHYSICIAN:** None.

## 5. FIRE-FIGHTING MEASURES

**FLASH POINT:** -156°F (-104°C)

**AUTOIGNITION:** 842°F (432°C)

**IGNITION TEMPERATURE IN AIR:** 920-1120°F

**FLAMMABLE LIMITS IN AIR BY VOLUME:** Lower: 2.15% Upper: 9.6%

**EXTINGUISHING MEDIA:** Dry chemical, CO<sub>2</sub>, water spray or fog for surrounding area. Do not extinguish fire until propane source is shut off.



**SPECIAL FIRE-FIGHTING INSTRUCTIONS:** Evacuate personnel from danger area. Evacuated personnel should stay upwind, and away from tank ends, and move to a distance at least 1 mile or more away from containers subject to direct flame. Immediately cool container(s) (especially upper half) with water spray from maximum distance and the sides of containers, taking care not to extinguish flames. If flames are extinguished, explosive re-ignition may occur. Stop flow of gas, if possible without risk, while continuing cooling water spray.

**UNUSUAL FIRE AND EXPLOSION HAZARDS:** Propane is easily ignited. It is heavier than air; therefore, it can collect in low areas while dissipating. Vapors may be moved by wind or water spray. Vapors may move to areas where ignition sources are present and ignite, flashing back to the source. Pressure in a container can build up due to heat and container may rupture if pressure relief devices should fail to function.

**HAZARDOUS COMBUSTION PRODUCTS:** In typical use in properly adjusted and maintained gas appliances--None. If propane combustion is incomplete, poisonous carbon monoxide (CO) may be produced. Defective, improperly installed, adjusted, maintained, or improperly vented appliances may produce carbon monoxide or irritating aldehydes.

### 6. ACCIDENTAL RELEASE MEASURES

**STEPS TO BE TAKEN IF MATERIAL IS RELEASED OR SPILLED:** Evacuate the immediate area. Eliminate any possible sources of ignition and provide maximum ventilation. Shut off source of propane, if possible. If leaking from container or valve, contact your supplier and/or fire department.

### 7. HANDLING AND STORAGE

**HANDLING PRECAUTIONS:** Propane vapor is heavier than air and can collect in low areas that are without sufficient ventilation. Leak-check system with a leak detector or approved solution, never with flame. Make certain the container service valve is shut off prior to connecting or disconnecting. If container valve does not operate properly, discontinue use and contact supplier. Never insert an object (*e.g.*, wrench, screwdriver, pry bar, etc.) into pressure relief valve or cylinder cap openings. Do not drop or abuse cylinder. Never strike an arc on a gas container or make a container part of an electrical circuit. See [Section] 16.

**OTHER INFORMATION** for additional precautions.

**STORAGE PRECAUTIONS:** Store in a safe, authorized location (outside, detached storage is preferred) with adequate ventilation. Specific requirements are listed in NFPA 58, *Liquefied Petroleum Gas Code*. Isolate from heat and ignition sources. Containers should never be allowed to reach temperature exceeding 125°F (52°C). Isolate from combustible materials. Provide separate storage locations for other compressed and flammable gases. Propane containers should be separated from oxygen cylinders, or other oxidizers, by a minimum distance of 20 feet, or by a barrier of non-combustible material at least 5 feet high, having a fire rating of at least 1 hour. Full and empty cylinders should be segregated. Store cylinders in upright position, or with pressure relief valve in

vapor space. Cylinders should be arranged so that pressure relief valves are not directed toward other cylinders. Do not drop or abuse cylinders. Keep container valve closed and plugged or capped when not in use. Install protective caps when cylinders are not connected for use. Empty containers retain some residue and should be treated as if they were full.

## **8. EXPOSURE CONTROLS/PERSONAL PROTECTION**

### **ENGINEERING CONTROLS**

#### **Ventilation:**

Provide ventilation so propane does not reach a flammable mixture.

#### **Ignition Source Control:**

Electrical wiring in liquid transfer areas must be Class I, Group D, and explosion-proof. Other possible ignition sources should be kept away from transfer areas. NO SMOKING signs should be posted at all approaches and entries to transfer areas. Transfer and storage areas must be kept free of flammables, combustibles and vegetation.

### **RESPIRATORY PROTECTION (SPECIFY TYPE)**

**General Use:** None.

#### **Emergency Use:**

If concentrations are high enough to warrant supplied-air or self-contained breathing apparatus, then the atmosphere may be flammable (See Section 5). Appropriate precautions must be taken regarding flammability.

#### **PROTECTIVE CLOTHING:**

Avoid skin contact with liquid propane because of possibility of freeze burn. Wear gloves and protective clothing which are impervious to the product for the duration of the anticipated exposure.

#### **EYE PROTECTION:**

Safety glasses are recommended when filling and handling cylinders.

#### **OTHER PROTECTIVE EQUIPMENT:**

Safety shoes are recommended when handling cylinders.

## **9. EXPOSURE CONTROLS/PERSONAL PROTECTION**

**BOILING POINT:** @ 14.7 psia = -44°F

**SPECIFIC GRAVITY (DENSITY) OF VAPOR (Air = 1) at 60°F:** 1.50

**SPECIFIC GRAVITY OF LIQUID (Water = 1) at 60°F:** 0.504

**VAPOR PRESSURE:** @ 70°F = 127 psig @ 105°F = 210 psig

**EXPANSION RATIO (from liquid to gas @ 14.7 psia):** 1 to 270

**SOLUBILITY IN WATER:** Slight, 0.1 to 1.0%

**APPEARANCE AND ODOR:** A colorless and tasteless gas at normal temperature and pressure. An odorant has been added to provide a strong unpleasant odor.

**ODORANT WARNING:** Odorant is added to aid in the detection of leaks. One common odorant is ethyl mercaptan, CAS No. 75-08-01. Odorant has a foul smell. The ability of people to detect odors varies widely. In addition, certain chemical reactions with material in the propane system, or fugitive

propane gas from underground leaks passing through certain soils can reduce the odor level. No odorant will be 100% effective in all circumstances. If odorant appears to be weak, notify propane supplier immediately.

### 10. STABILITY AND REACTIVITY

**STABILITY:** Stable.

**Conditions to avoid:** Keep away from high heat, strong oxidizing agents and sources of ignition.

**REACTIVITY:**

Hazardous Decomposition Products: Products of combustion are fumes, smoke, carbon monoxide and aldehydes and other decomposition products. Incomplete combustion can cause carbon monoxide, a toxic gas, while burning or when used as an engine fuel.

**Hazardous polymerization:** Will not occur.

### 11. TOXICOLOGICAL INFORMATION

Propane is non-toxic and is a simple asphyxiant; however, it does have slight anesthetic properties and higher concentrations may cause dizziness.

**[IRRITANCY OF MATERIAL]:** None

**[SENSITIZATION TO MATERIAL]:** None

**[REPRODUCTIVE EFFECTS]:** None

**[TERATOGENICITY]:** None

**[MUTAGENICITY]:** None

**[SYNERGISTIC MATERIALS]:** None

### 12. ECOLOGICAL INFORMATION

No adverse ecological effects are expected. Propane does not contain any Class I or Class II ozone-depleting chemicals (40 CFR Part 82.) Propane is not listed as a marine pollutant by DOT (49 CFR Part 171).

### 13. DISPOSAL CONSIDERATIONS

**WASTE DISPOSAL METHOD:**

Do not attempt to dispose of residual or unused product in the container. Return to supplier for safe disposal.

Residual product within process system may be burned at a controlled rate, if a suitable burning unit (flare stack) is available on site. This shall be done in accordance with federal, state and local regulations.

## 14. TRANSPORTATION INFORMATION

**DOT SHIPPING NAME:** Liquefied Petroleum Gas

**HAZARD CLASS:** 2.1 (Flammable Gas)

**IDENTIFICATION NUMBER:** UN 1075

**PRODUCT RQ:** None

**SHIPPING LABEL(S):** Flammable gas

**IMO SHIPPING NAME:** Propane

**PLACARD (When Required):** Flammable gas

**IMO IDENTIFICATION NUMBER:** UN 1978

**SPECIAL SHIPPING INFORMATION:**

Container should be transported in a secure, upright position in a well-ventilated vehicle.

## 15. REGULATORY INFORMATION

The following information concerns selected regulatory requirements potentially applicable to this product. Not all such requirements are identified. Users of this product are responsible for their own regulatory compliance on a federal, state [provincial] and local level.

### U.S. FEDERAL REGULATIONS:

**EPA** - Environmental Protection Agency

**CERCLA** - Comprehensive Environmental Response, Compensation and Liability Act of 1980  
(40 CFR Parts 117 and 302):  
Reportable Quantity (RQ): None

**SARA** - Superfund Amendment and Reauthorization Act

- **SECTIONS 302/304:** Require emergency planning on threshold planning quantities (TPQ) and release reporting on reportable quantities (RQ) of EPA extremely hazardous substances (40 CFR Part 355).

Extremely Hazardous Substances: None

Threshold Planning Quantity (TPQ): None

- **SECTIONS 311/312:** Require submission of material safety data sheets (MSDSs) and chemical inventory reporting with identification of EPA-defined hazard classes (40 CFR Part 370). The hazard classes for this product are:

IMMEDIATE: Yes

PRESSURE: Yes

DELAYED: No

REACTIVITY: No

FLAMMABLE: Yes

- **SECTION 313:** Requires submission of annual reports of release of toxic chemicals that appear in 40 CFR Part 372.

## Appendix B: Material Safety Data Sheet

Propane does not require reporting under Section 313.

### 40 CFR PART 68 Risk Management for Chemical Accidental Release

**TSCA** - Toxic Substance Control Act  
Propane is not listed on the TSCA inventory.

**OSHA** - Occupational Safety and Health Administration  
29 CFR 1910.119: Process Safety Management of Highly Hazardous Chemicals.

**FDA** - Food and Drug Administration

**21 CFR 184.1655:** Generally recognized as safe (GRAS) as a direct human food ingredient when used as a propellant, aerating agent and gas.

### 16. OTHER INFORMATION

**SPECIAL PRECAUTIONS:** Use piping and equipment adequately designed to withstand pressures to be encountered.

NFPA 58 *Liquefied Petroleum Gas Code* and OSHA 29 CFR 1910.110 require that all persons employed in handling LP-gases be trained in proper handling and operating procedures, which the employer shall document. Contact your propane supplier to arrange for the required training. Allow only trained and qualified persons to install and service propane containers and systems.

**WARNING:** Be aware that with odorized propane, the intensity of ethyl mercaptan stench (its Odor) may fade due to chemical oxidation (in the presence of rust, air or moisture), adsorption or absorption. Some people have nasal perception problems and may not be able to smell the ethyl mercaptan stench. Leaking propane from underground lines may lose its odor as it passes through certain soils. While ethyl mercaptan may not impart the warning of the presence of propane in every instance, it is generally effective in a majority of situations. Familiarize yourself, your employees and customers with this warning and other facts associated with the so-called odor-fade phenomenon. If you do not already know all the facts, contact your propane supplier for more information about odor, electronic gas alarms and other safety considerations associated with the handling, storage and use of propane.

Issue Date: November, 2001

### ISSUE INFORMATION

This material safety data sheet and the information it contains is offered to you in good faith as accurate. Much of the information contained in this data sheet was received from outside sources. To the best of our knowledge this information is accurate, but the Propane Education and Research Council does not guarantee its accuracy or completeness. Health and safety precautions in this

data sheet may not be adequate for all individuals and/or situations. It is the user's obligation to evaluate and use this product safely, comply with all applicable laws and regulations and to assume the risks involved in the use of this product.

NO WARRANTY OF MERCHANTABILITY, FITNESS FOR ANY PARTICULAR PURPOSES, OR ANY OTHER WARRANTY IS EXPRESSED OR IS TO BE IMPLIED REGARDING THE ACCURACY OR COMPLETENESS OF THIS INFORMATION, THE RESULTS TO BE OBTAINED FROM THE USE OF THIS INFORMATION OR THE PRODUCT, THE SAFETY OF THIS PRODUCT, OR THE HAZARDS RELATED TO ITS USE.

*The purpose of this MSDS is to set forth general safety information and warnings related to the use of propane. It is not intended to be an exhaustive treatment of the subject, and should not be interpreted as precluding other authoritative information or safety procedures which would enhance safe LP-gas storage, handling or use. Issuance of this MSDS is not intended nor should it be construed as an undertaking to perform services on behalf of any party either for their protection or for the protection of third parties. The Propane Education and Research Council assumes no liability for reliance on the contents of this material safety data sheet.*





Copyright © 2012 Propane Education & Research Council



Propane Education & Research Council  
1140 Connecticut Avenue, N.W. Ste. 1075  
Washington, D.C. 20036  
(202) 452-8975

PRC 003615